

UniPlay Ebriente

420 080 10

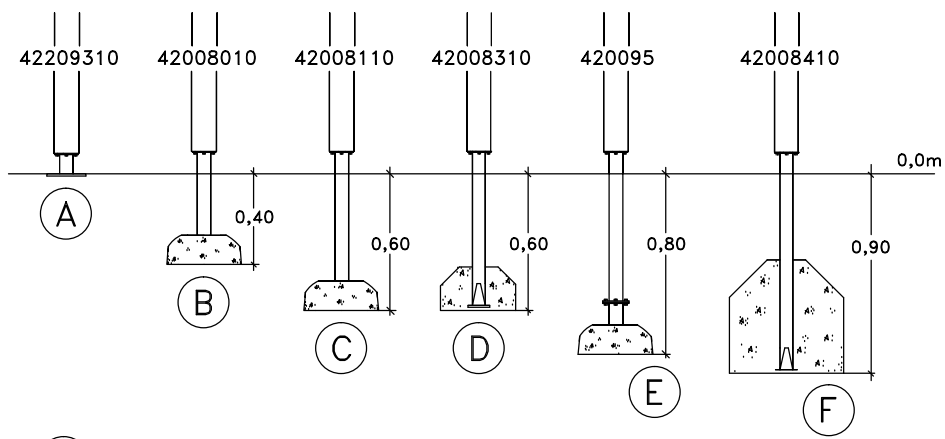

- (A) 8049058, 8049151, 8049156
- (B) 8048388, 8049154, 8049159
- (D) 8049059, 8049152, 8049157
- (E) 8049061, 8049153, 8049158

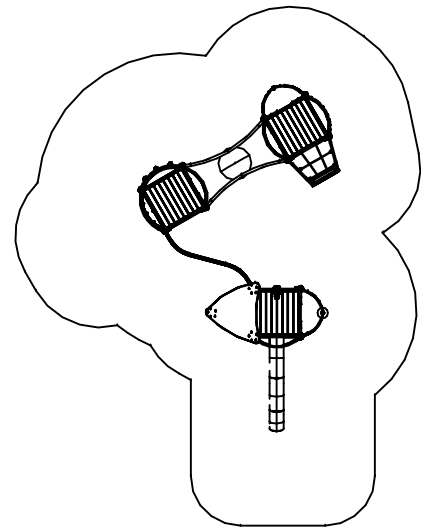

HAGS ANEBY, SWEDEN
 +46(0)380-47300
 www.hags.com

UniPlay Ebriente
 8048388
 2/8

EF OG 2015 01 23

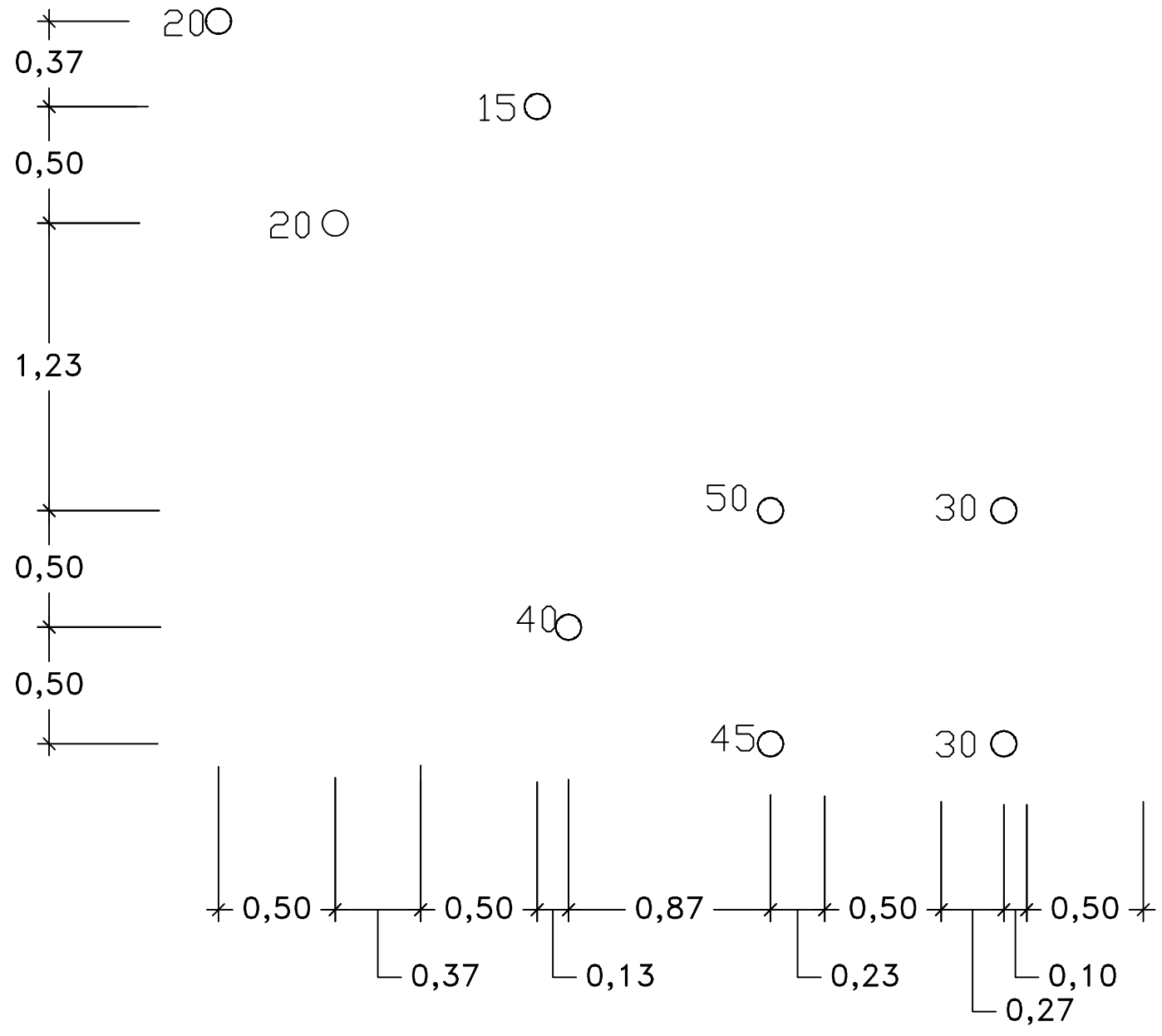
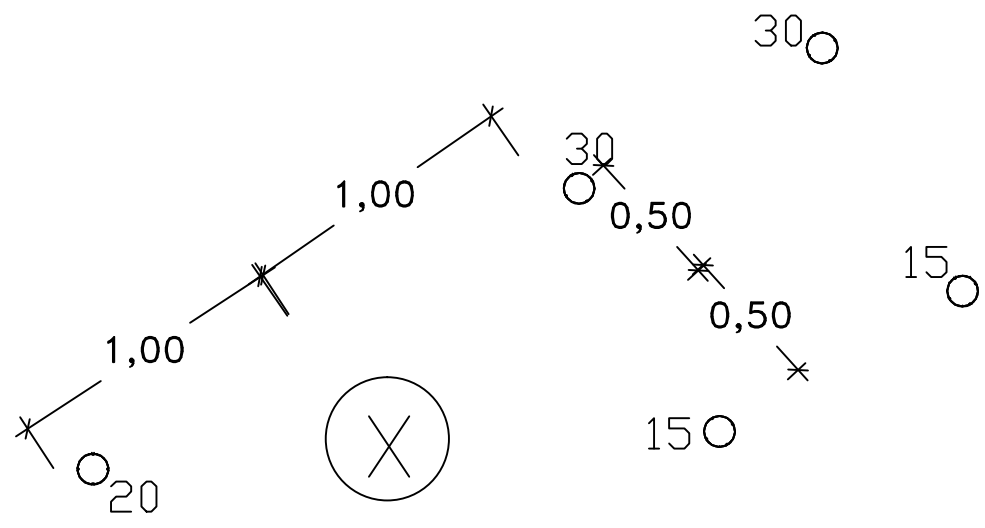
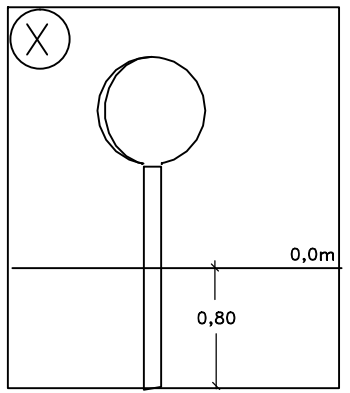

1	= L: 1550
5	= L: 1700
10	= L: 2000
15	= L: 2300
20	= L: 2450
25	= L: 2600
30	= L: 2900
35	= L: 3130
40	= L: 3200
45	= L: 3500
50	= L: 3800
55	= L: 4100
60	= L: 4250
65	= L: 4400
70	= L: 4465
75	= L: 4550
80	= L: 4700
85	= L: 5000

STEP 1

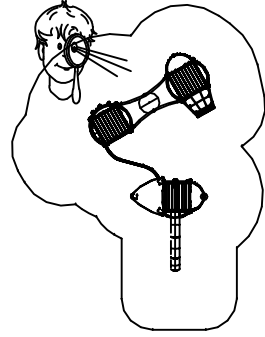

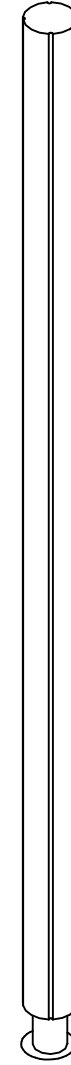
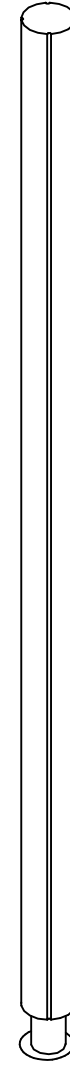
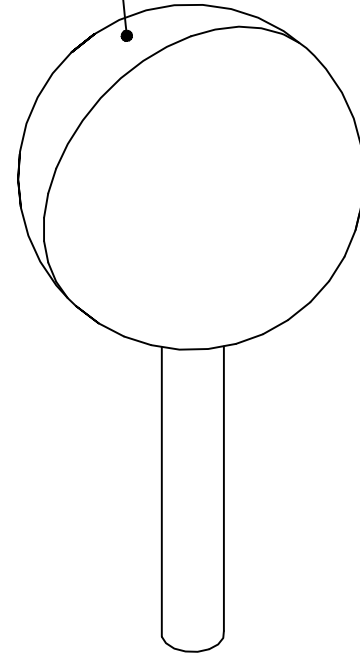
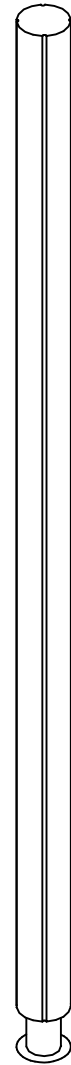

 MASW 37993



HAGS

ANEBY, SWEDEN
+46(0)380-47300
www.hags.com

UniPlay Ebriente
8048388
3/8

    2015 01 23

STEP 2

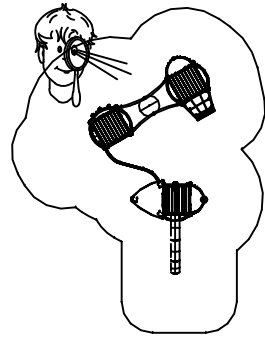

4111
3x 1x1m

+1,50

MASW 39775

MASW 35168

+2,25

426 162

MASW 39776
(x2)

0,79

+0,50

MASW 37573

+1,00

+0,50

MASW 37573

HAGS ANEBY, SWEDEN
+46(0)380-47300
www.hags.com

UniPlay Ebriente
8048388
4/8

EF OG 2015 01 23

STEP 2

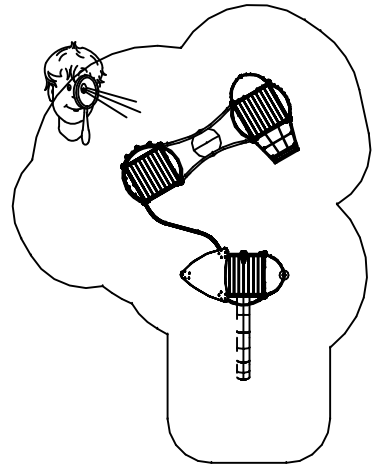

 MASW 35330

2

 MASW 35698

1

2

1

5



6

2

1

HAGS ANEBY, SWEDEN
+46(0)380-47300
www.hags.com

UniPlay Ebriente
8048388
6/8

 EF  OG 2015 01 23

STEP 3

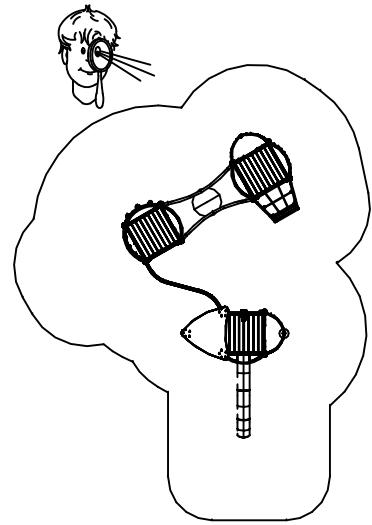

MASW 34935

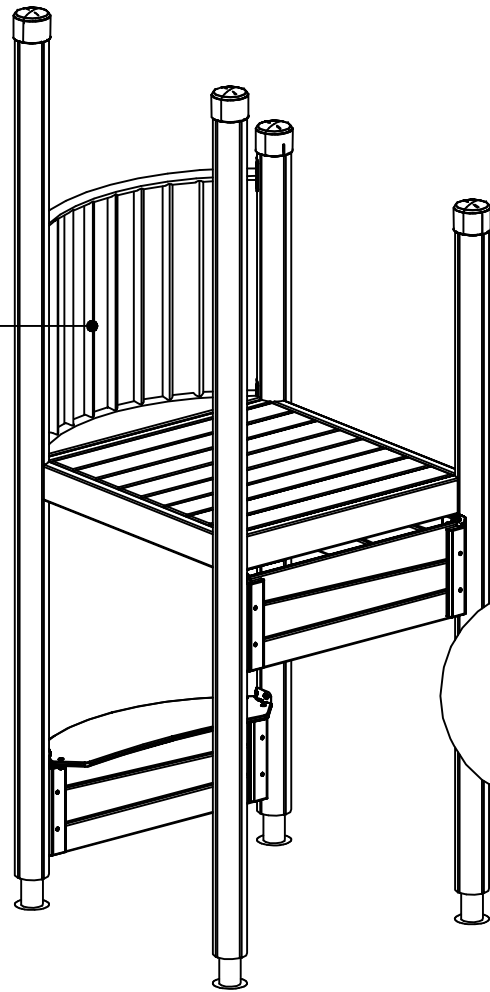

420 938 13

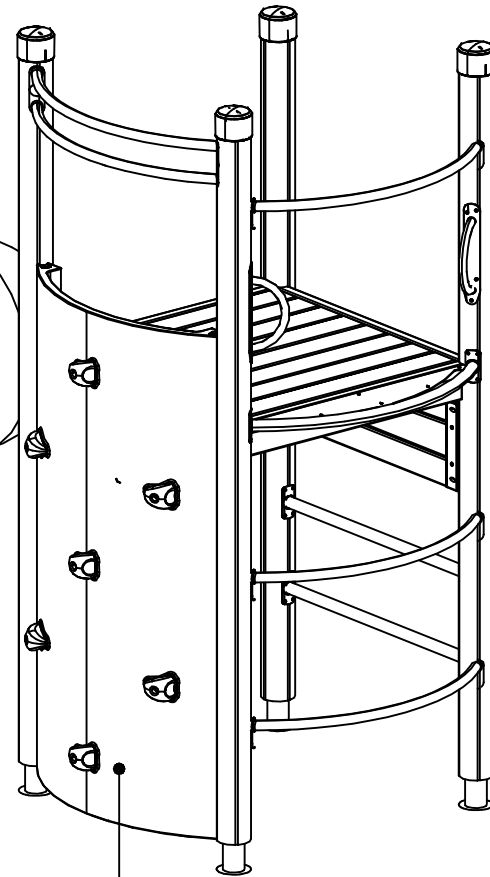

MASW 35156

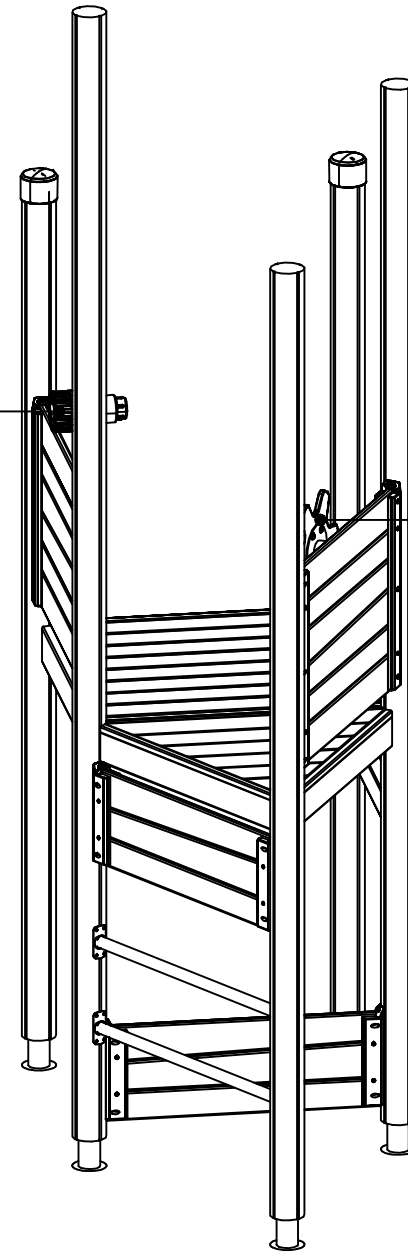

MASW 39686

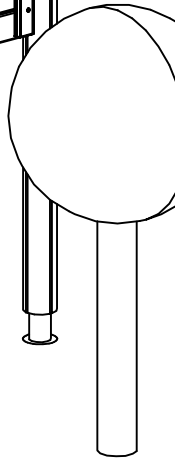

HAGS

ANEBY, SWEDEN
+46(0)380-47300
www.hags.com

UniPlay Ebriente

8048388

6/8

STEP 4

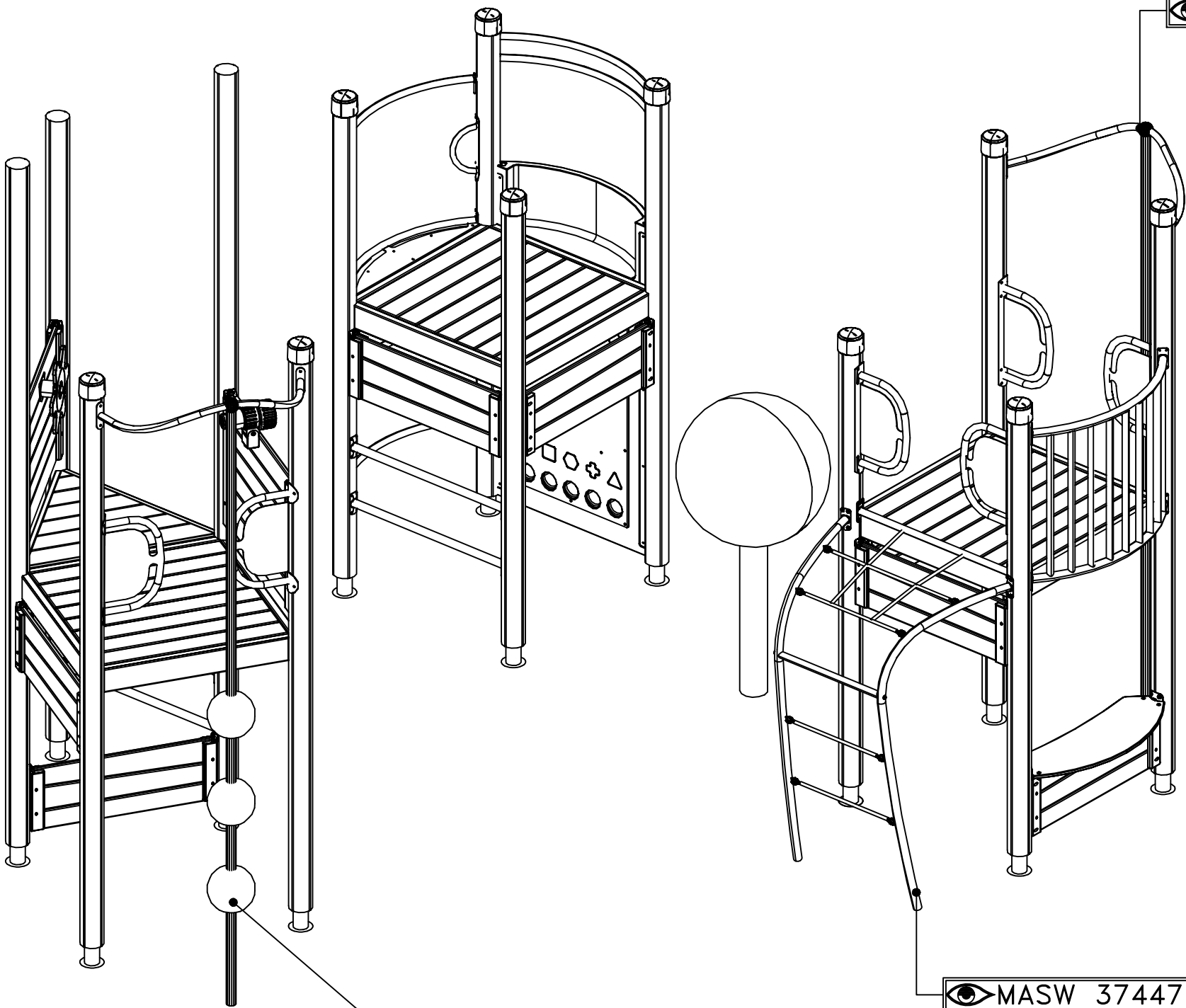
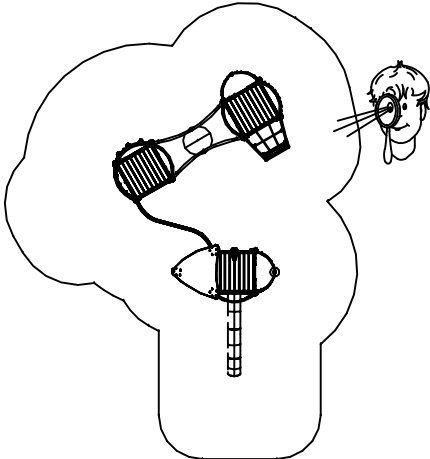

420 770 10

420 771 51

MASW 37447

HAGS ANEBY, SWEDEN
+46(0)380-47300
www.hags.com

UniPlay Ebriente
8048388
7/8

EF OG 2015 01 23

STEP 5

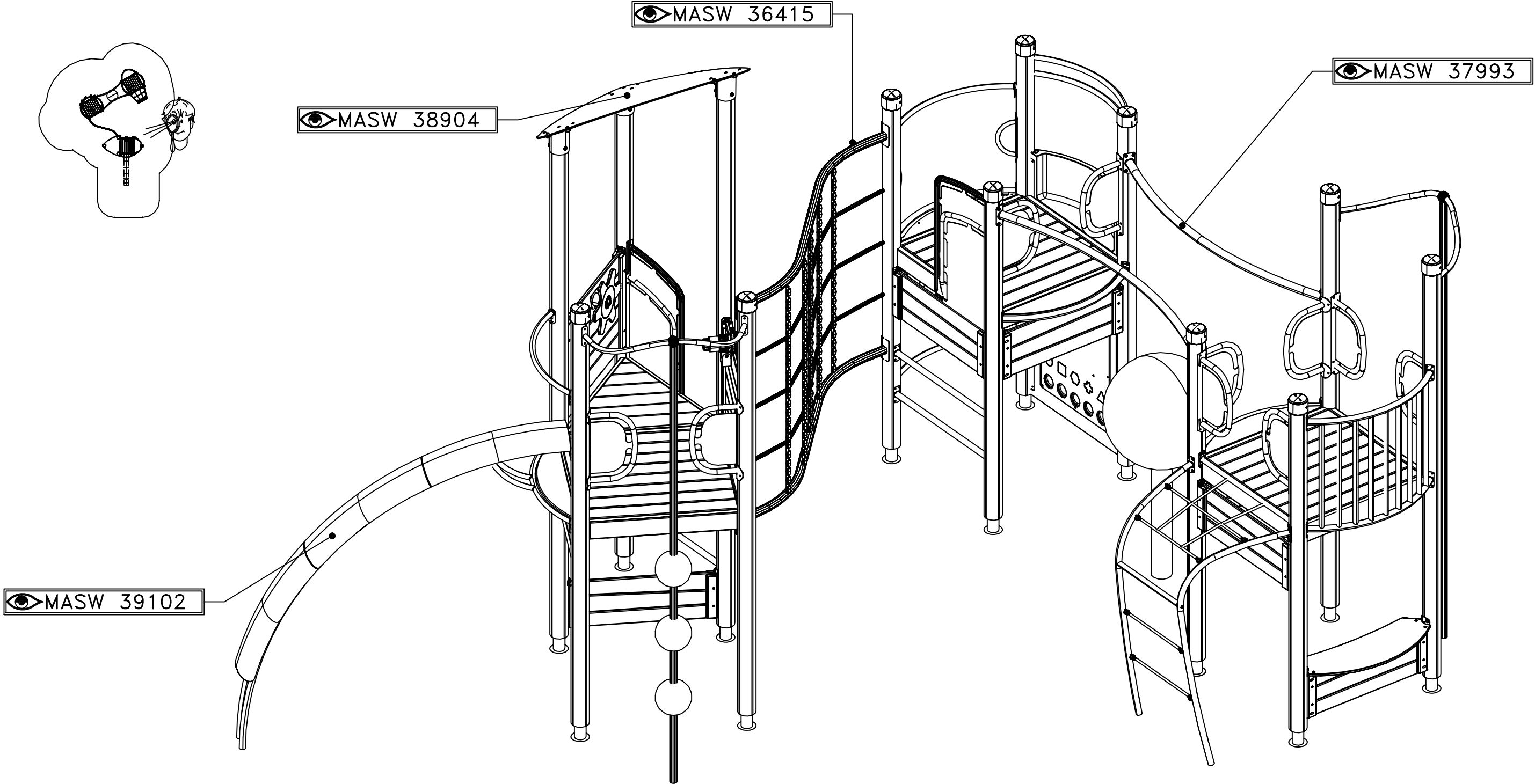
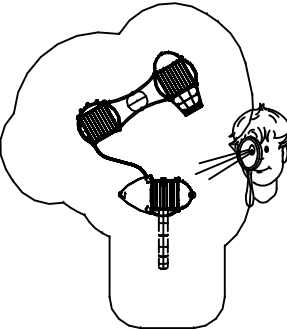

HAGS ANEBY, SWEDEN
+46(0)380-47300
www.hags.com

UniPlay Ebriente
8048388
8 / 8

EF OG 2015 01 23