

UniPlay Abbax

1:100
1,0m 5,0m

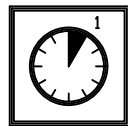

28h

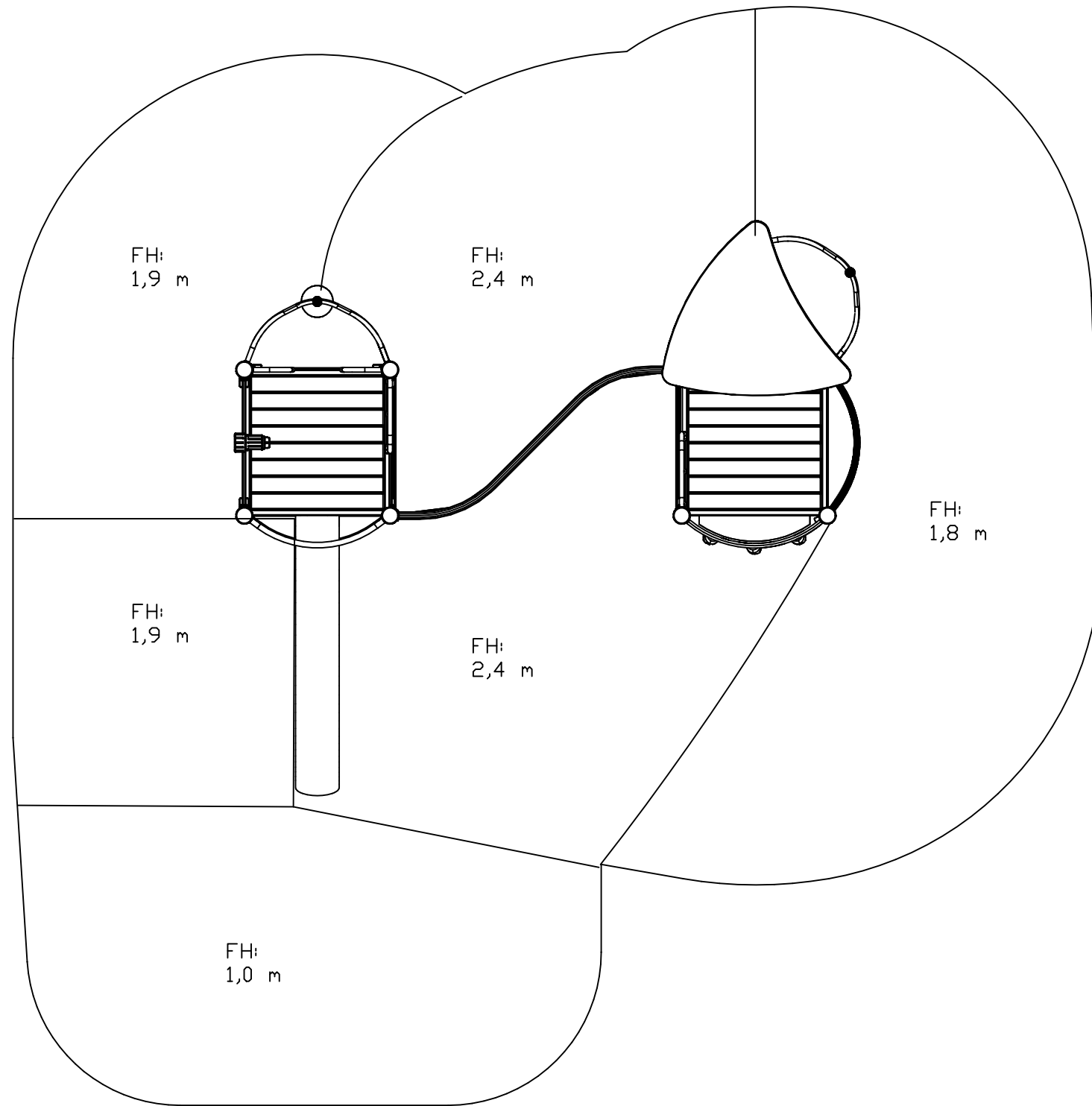
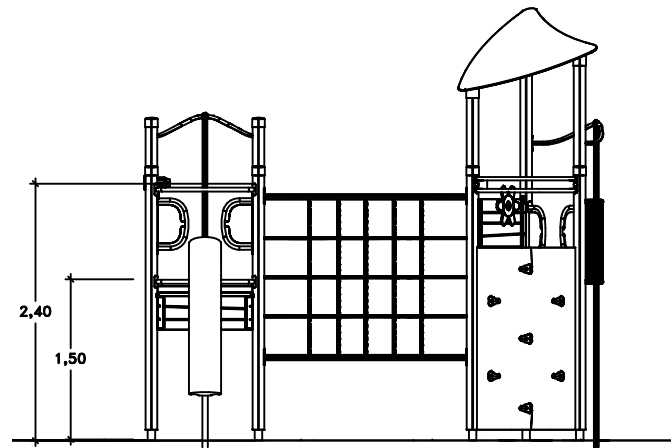
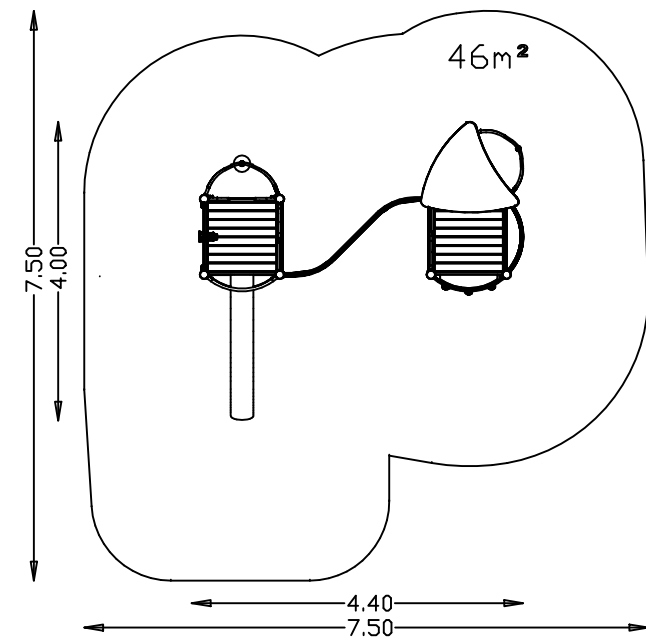

Varje vecka
Every week
Jede woche
Chaque semaine



Varje säsong
Every season
Jedes Jahr
Chaque saison

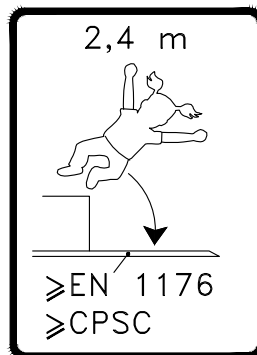

Step by Step UniPlay

1. ...
2. ...
3. ...
4. ...
5. ...
6. ...
7. ...
8. ...
9. ...
10. ...

Handledning
① ...
② ...
③ ...
④ ...
⑤ ...
⑥ ...
⑦ ...
⑧ ...
⑨ ...
⑩ ...

SE 1(3)
HAGS
UniPlay Abbax
8048383

HAGS ANEBY, SWEDEN
+46(0)380-47300
www.hags.com

UniPlay Abbax
8048383
1/6

EF - 2017-01-26 1+

420 080 10

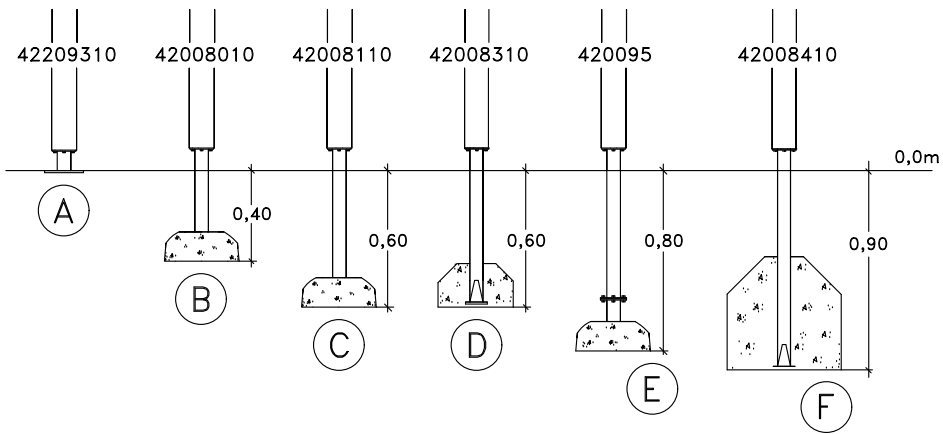

- (A) 8049088, 8049020, 8049097
- (B) 8048383, 8049091, 8049100
- (D) 8049022, 8049089, 8049098
- (E) 8049023, 8049090, 8049099

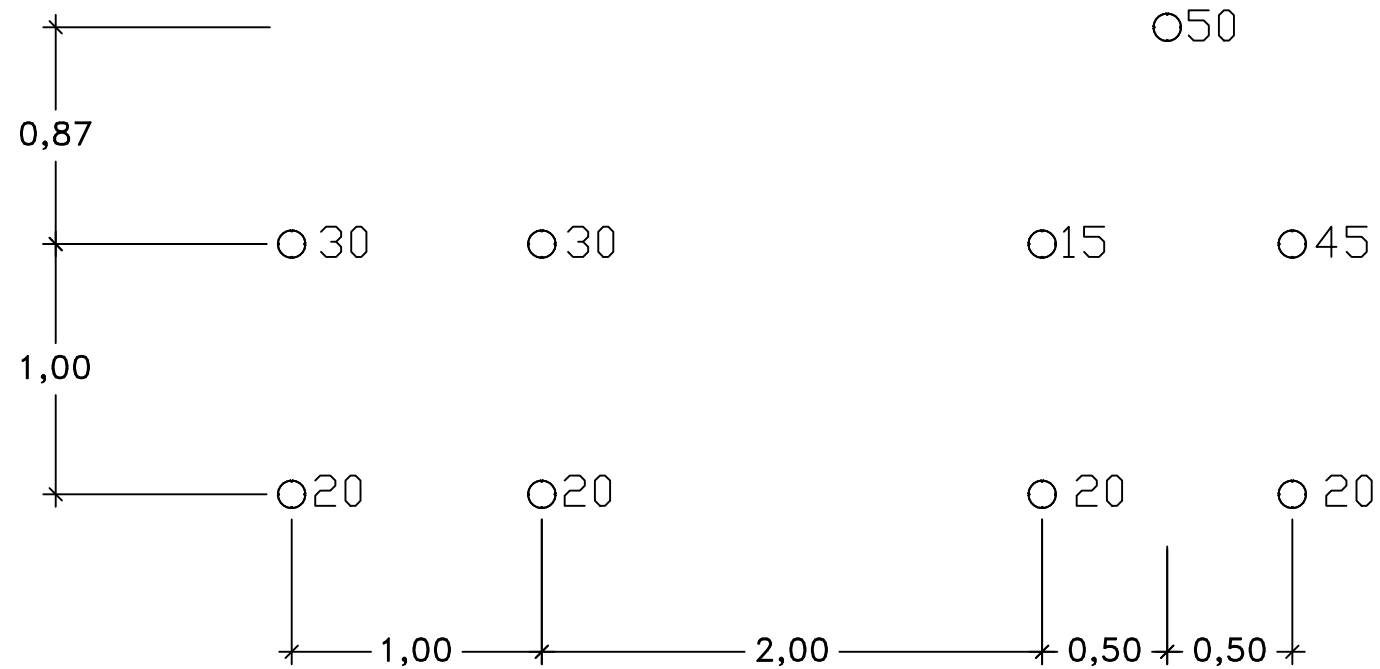
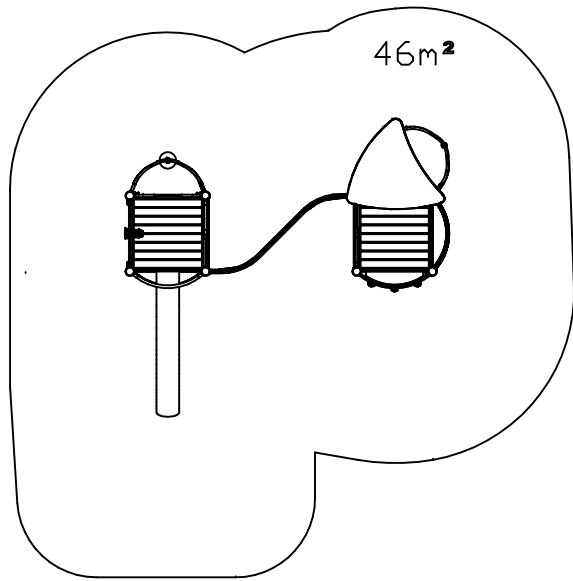

- 1 = L:1550
- 5 = L:1700
- 10 = L:2000
- 15 = L:2300
- 20 = L:2450
- 25 = L:2600
- 30 = L:2900
- 35 = L:3130
- 40 = L:3200
- 45 = L:3500
- 50 = L:3800
- 55 = L:4100
- 60 = L:4250
- 65 = L:4400
- 70 = L:4465
- 75 = L:4550
- 80 = L:4700
- 85 = L:5000

HAGS ANEBY, SWEDEN
+46(0)380-47300
www.hags.com

2/6

EF - - 0+

STEP 2

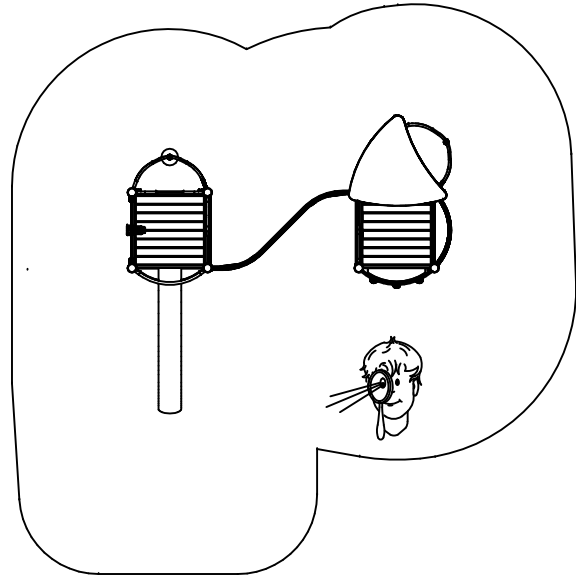

420 938 13

MASW 35698

5

2

1

MASW 35156

6

MASW 34935

5

HAGS ANEBY, SWEDEN
+46(0)380-47300
www.hags.com

4 / 6

EF - - 0+

STEP 3

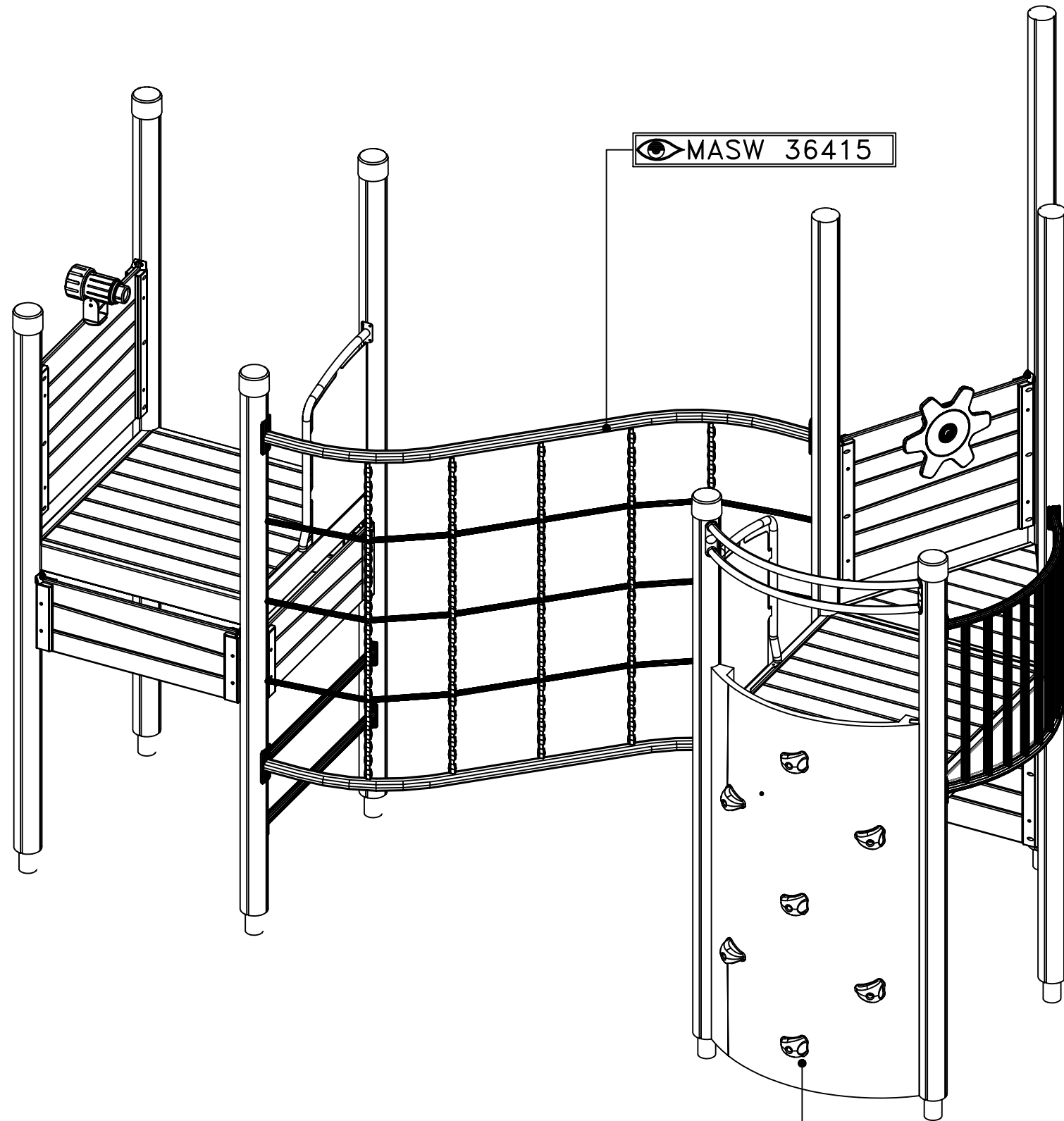
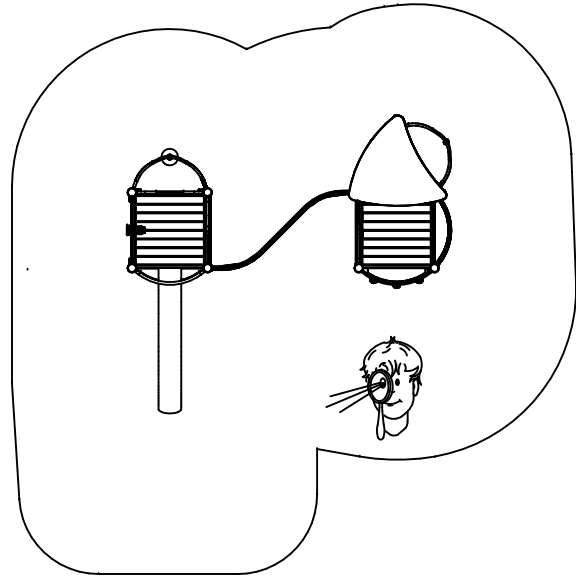

HAGS		ANEBY, SWEDEN	
		+46(0)380-47300	
		www.hags.com	
5 / 6			
	EF		0+

STEP 4

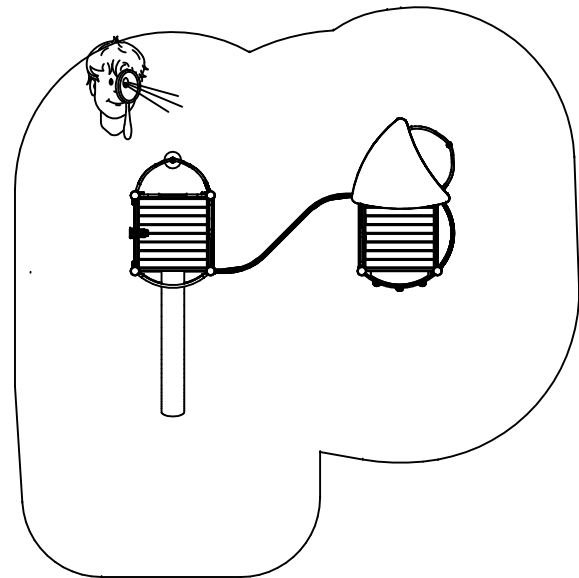

180°

420 770 10

MASW 38904

MASW 36147

420 771 51

HAGS ANEBY, SWEDEN
+46(0)380-47300
www.hags.com

6 / 6

EF - - 0+