

0,5 h

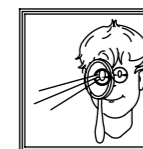

Varje vecka  
Every week  
Jede woche  
Chaque semaine

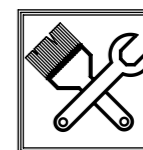

Varje säsong  
Every season  
Jedes Jahr  
Chaque saison

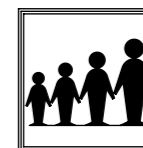

12-

NR.	Description MA	Item Number	QTY.
1	Hyperextension Bench	GYM504	1
2	Seat	8038197	1
3	WASHER-PLAIN-M10	10291000	8
4	SS NYLOC NUT M10	10261000	4
5	TORX+PIN M10 X 30	10121030	4

**HAGS** HAGS Aneby AB, Box 133, SE-578 23 Aneby, Sweden, Tel: +46 380 473 00, <http://www.hags.com>



**Hyperextension Bench**

**MASW43449**

1 ( 2 )

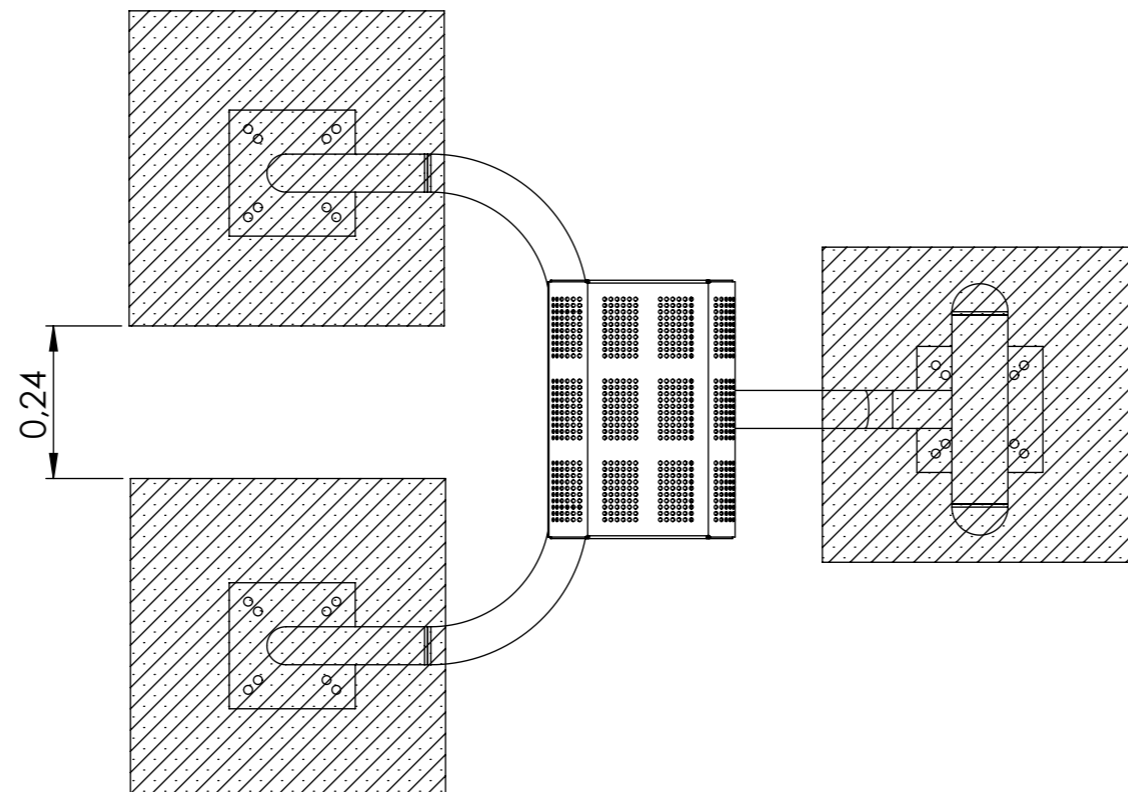
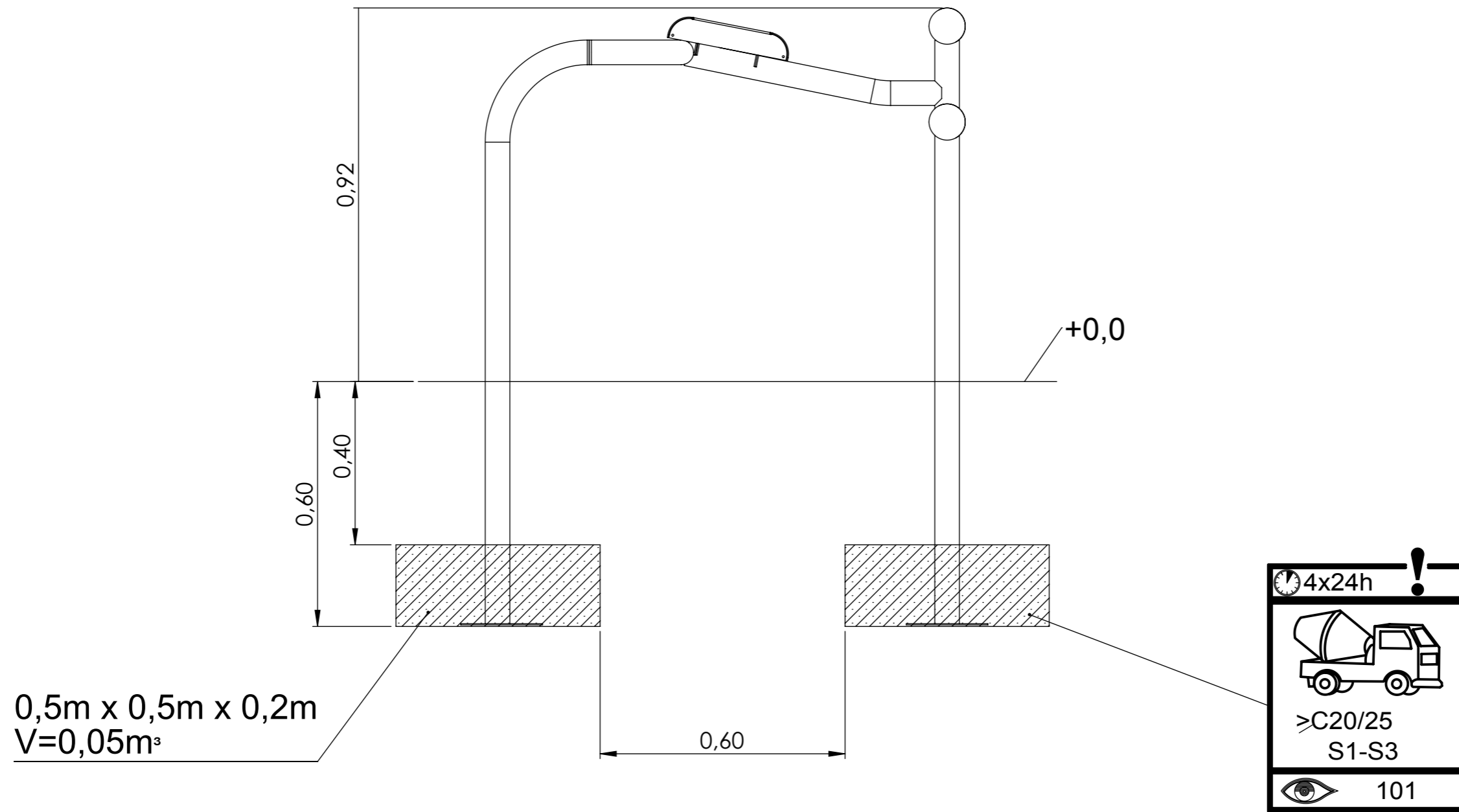
MN EF 2015-07-03 0



<b>HAGS</b>		HAGS Aneby AB, Box 133, SE-578 23 Aneby, Sweden, Tel: +46 380 473 00, <a href="http://www.hags.com">http://www.hags.com</a>	
<b>Hyperextension Bench</b>			
<b>MASW43449</b>			
2 ( 2 )			
	MN		EF
		2015-07-03	0