



Playgrounds **Fun & Easy!**[™]

Little Tikes[®] Tot Tree

MODEL # 200088461



installatten instructions

Little Tikes Tot Tree

PUB # TT9000020B
PAGE 2

SAFETY AND SURFACING SHEET (COMMERCIAL PLAY AREAS)

SUPERVISED

SUPERVISED

FOR UN-SUPERVISED AREA APPLICATIONS:

- A use zone of 36in (910mm) around all components of play structure.
- Separate from the play equipment for older children (2-5; 2-12; and 5-12 yrs)
- Since the highest elevated play surface is 7.5" (190mm), commercial resilient surfacing is not required. However, do not install on asphalt, concrete, packed earth, or other hard surfaces.
- If using loose-fill surfacing, install and anchor the equipment first before adding the loose-fill.
- If using unitary surfacing, install the surface first, then install and anchor the equipment.

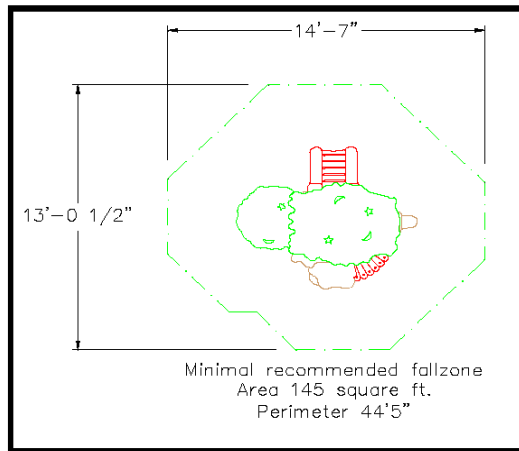

UN-SUPERVISED

UN-SUPERVISED

FOR UN-SUPERVISED AREA APPLICATIONS:

- A use zone of 72in (1830mm) around all components of play structure.
- Separate from the play equipment for older children (2-5; 2-12; and 5-12 yrs)
- Since the highest elevated play surface is 7.5" (190mm), commercial resilient surfacing is not required. However, do not install on asphalt, concrete, packed earth, or other hard surfaces.
- If using loose-fill surfacing, install and anchor the equipment first before adding the loose-fill.
- If using unitary surfacing, install the surface first, then install and anchor the equipment.

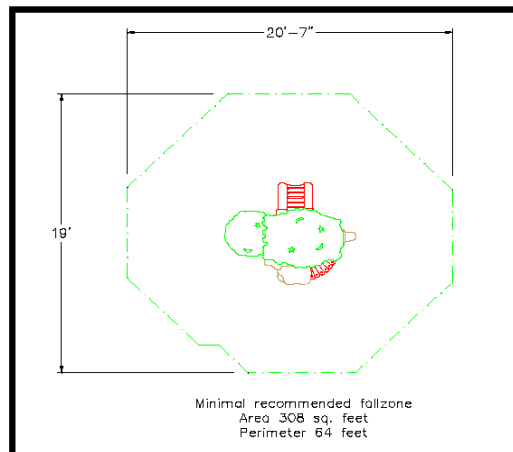

REFER TO SEPARATE
"SAFETY AND SURFACING SHEET"

PUB # TT9000020B
PAGE 3

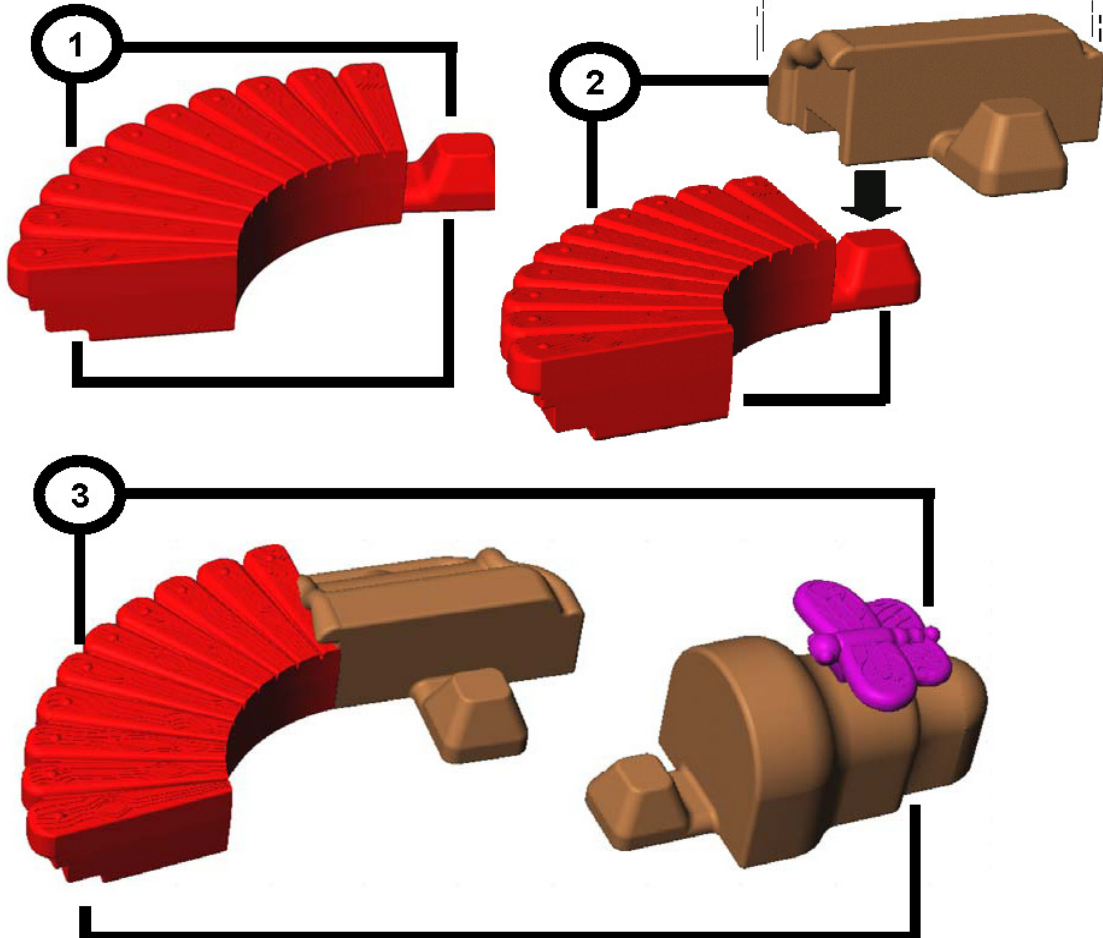
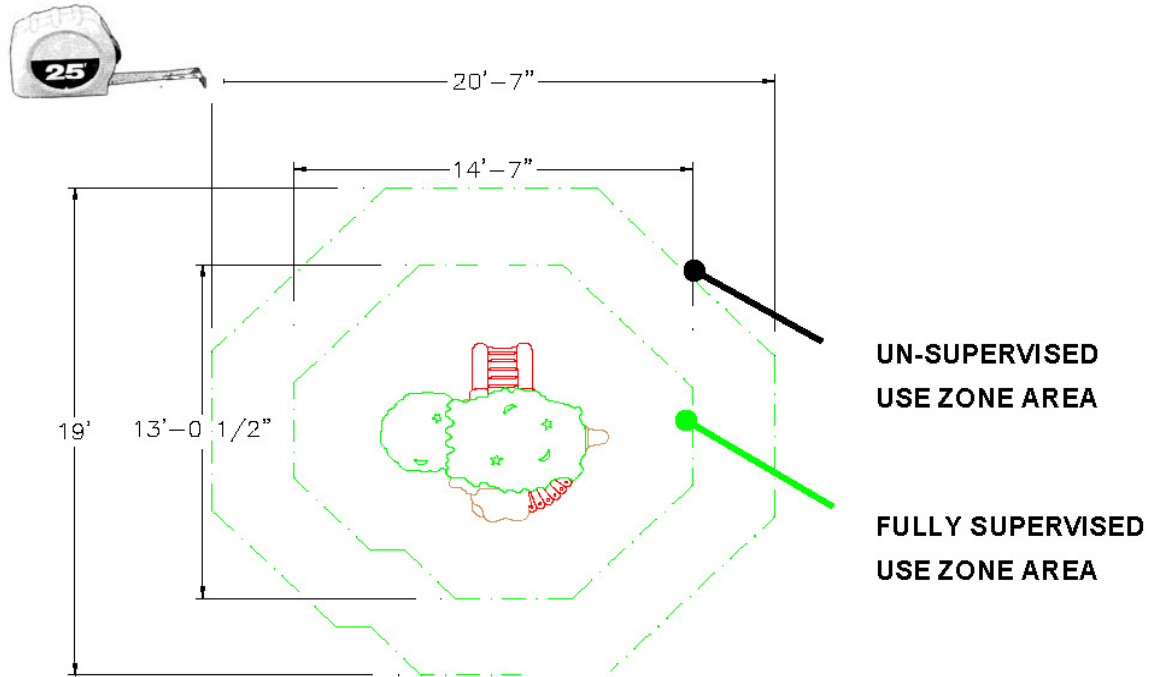

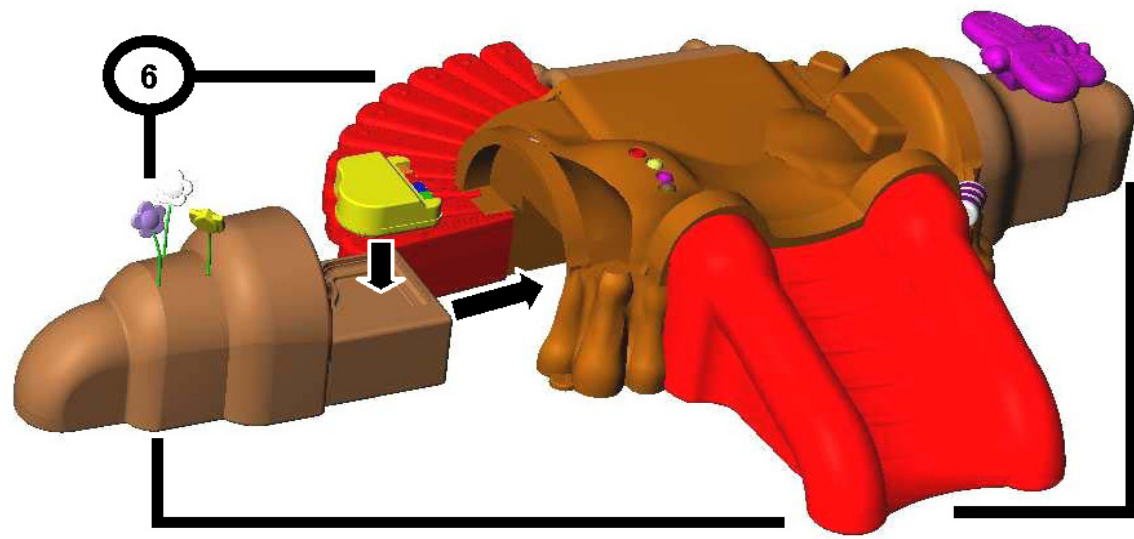
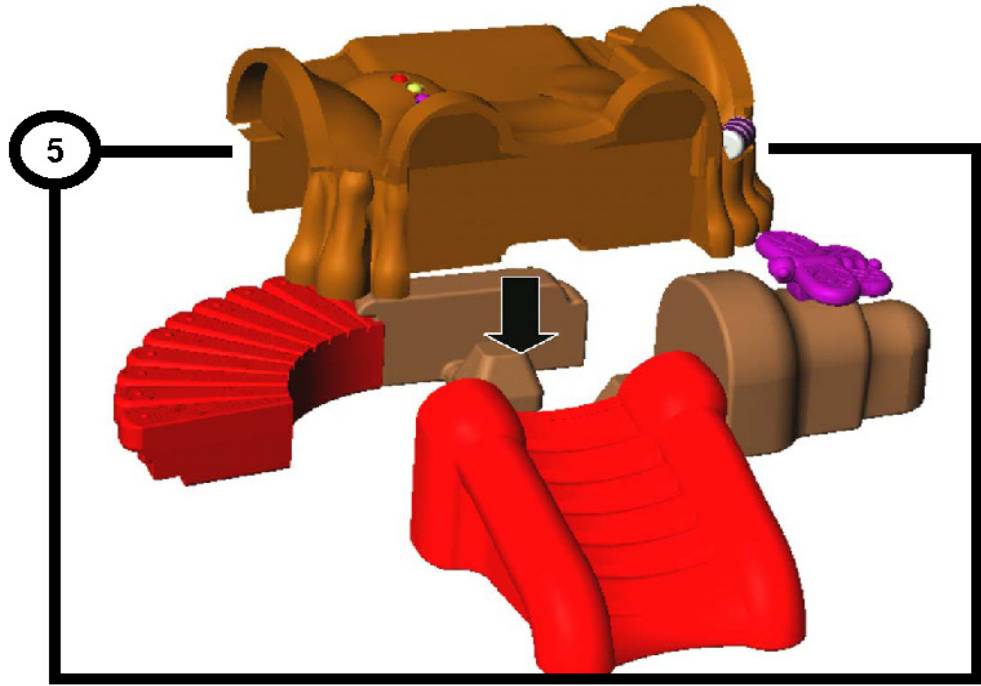
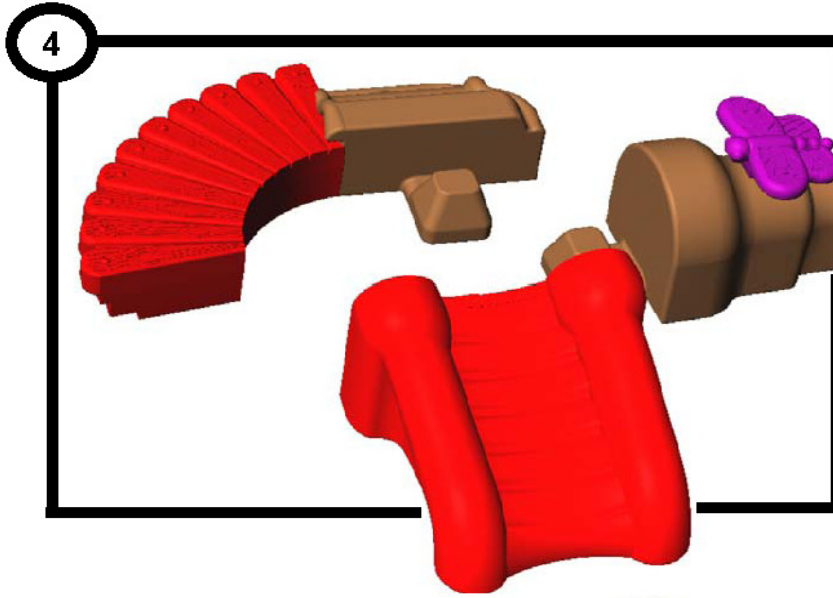

7

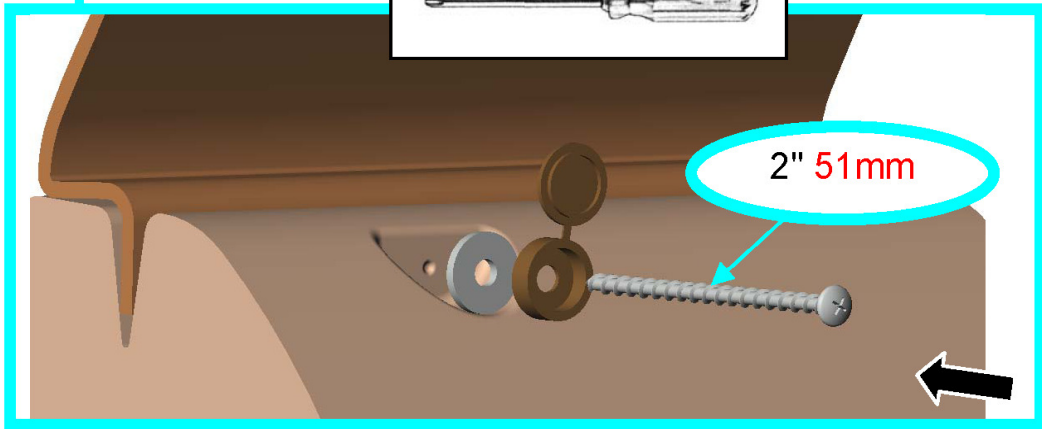
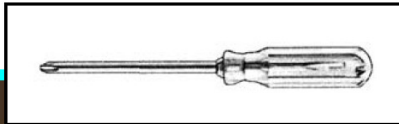
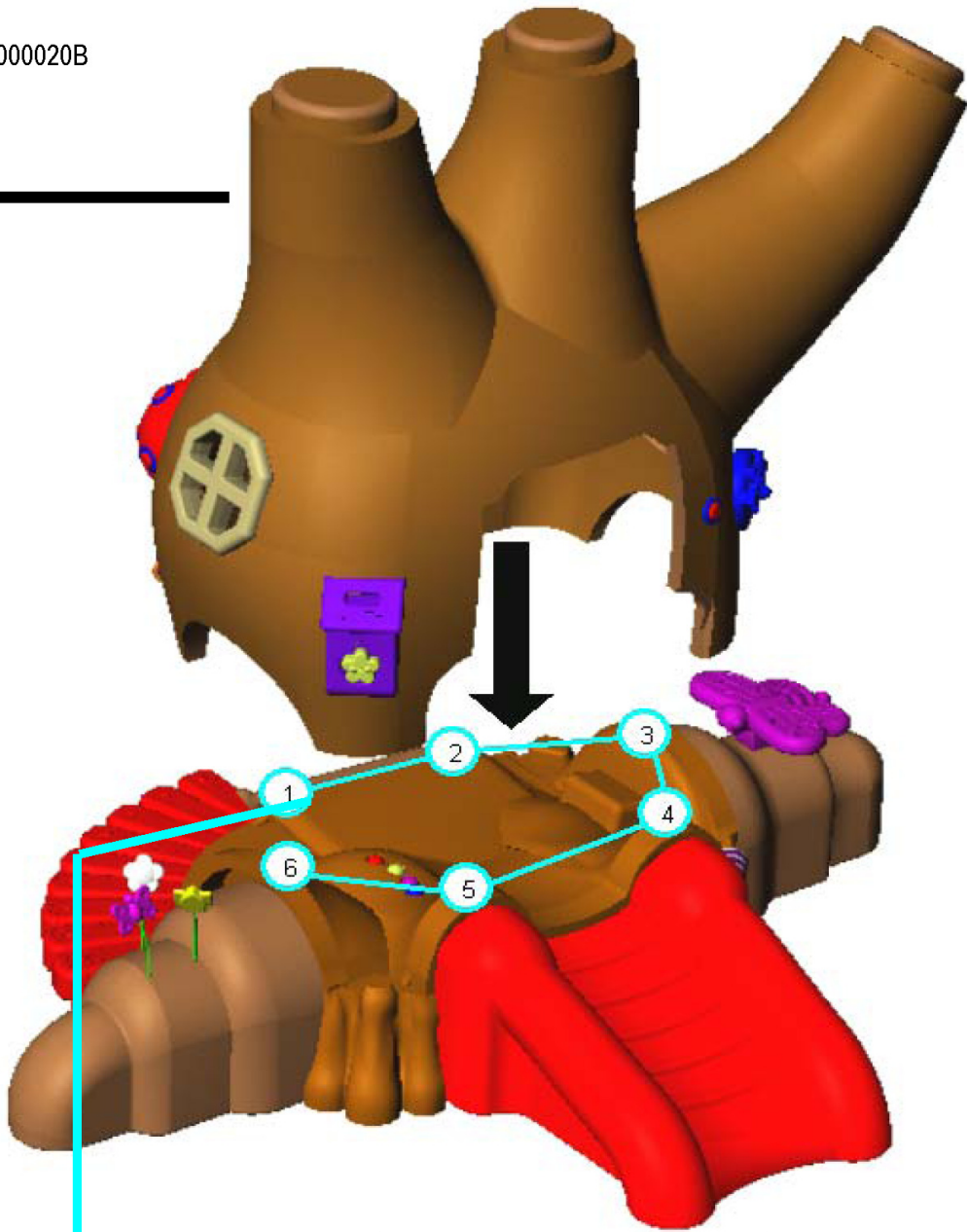

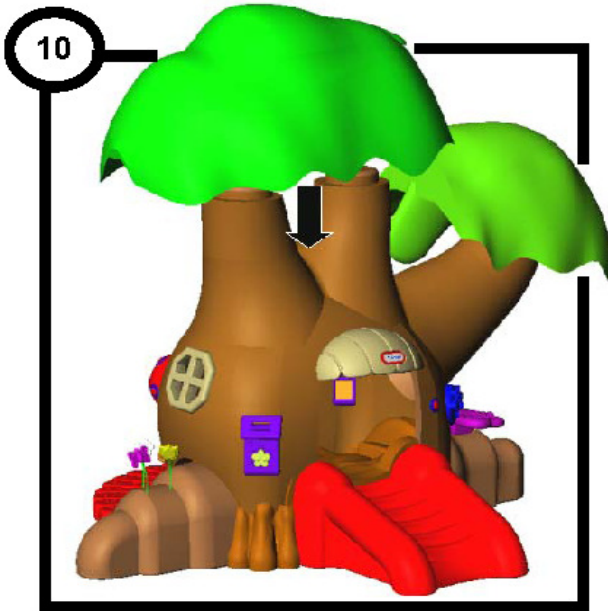
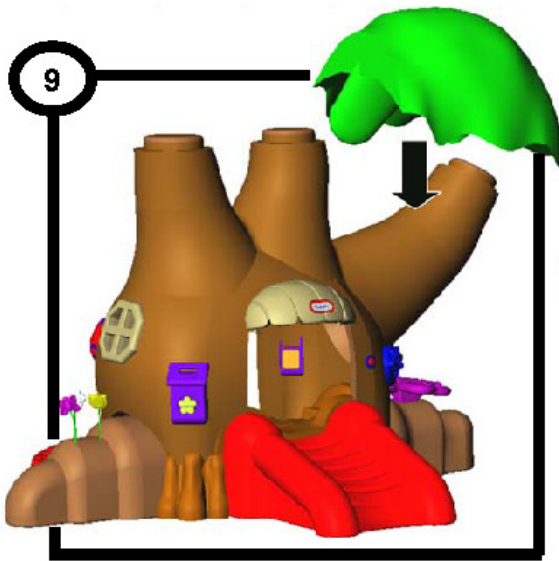
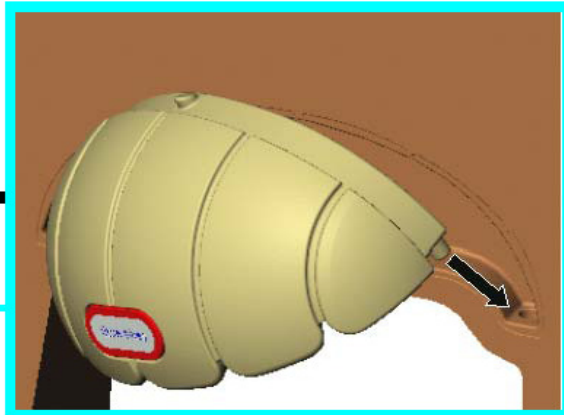
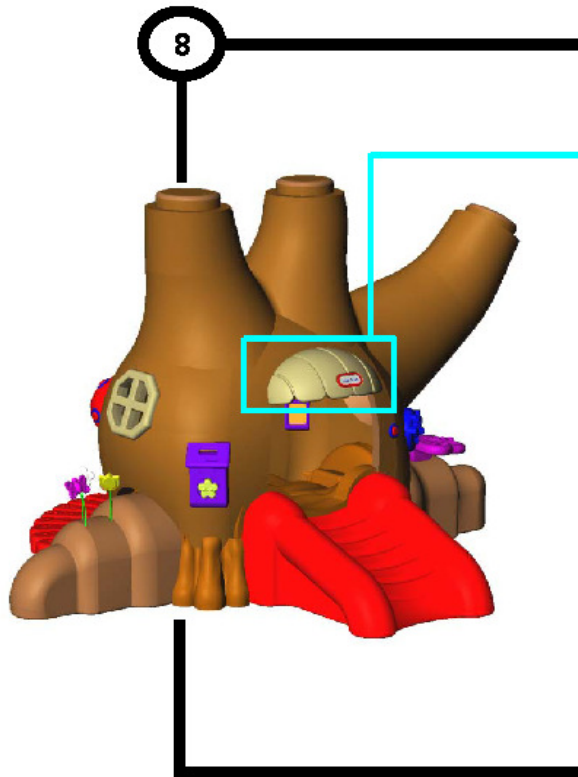

11

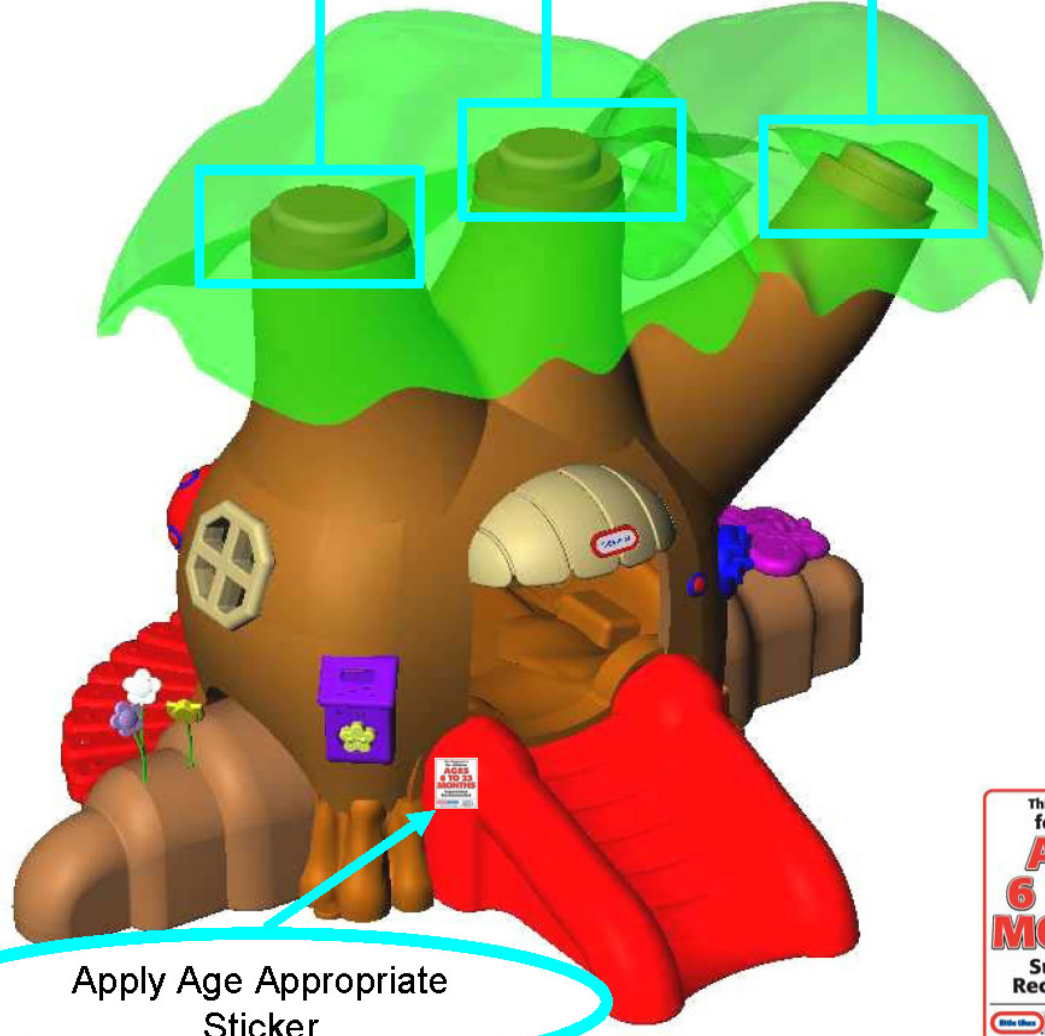
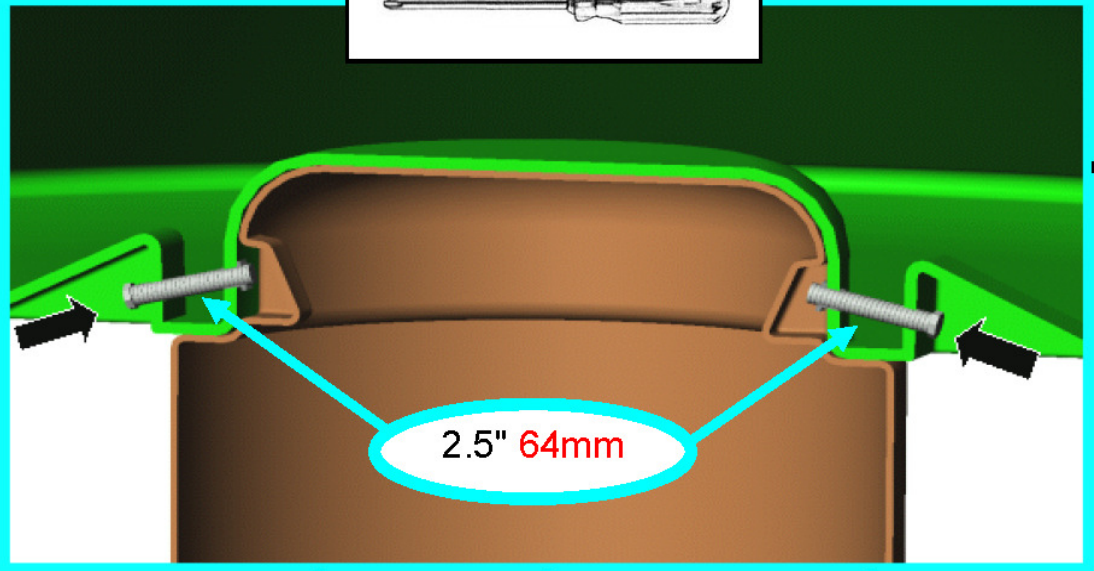
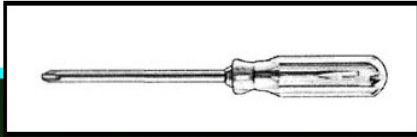

This Playground is
for children
**AGES
6 TO 23
MONTHS**
Supervision
Recommended

Slide One COMMERCIAL PLAYWORKS LTD.
Plymouth - 400 USA
1-800-543-8888
www.playworksusa.com
#PLAYWORKS

12

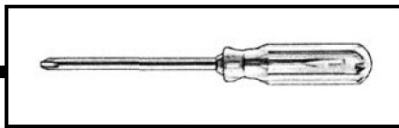

1
2

3
4

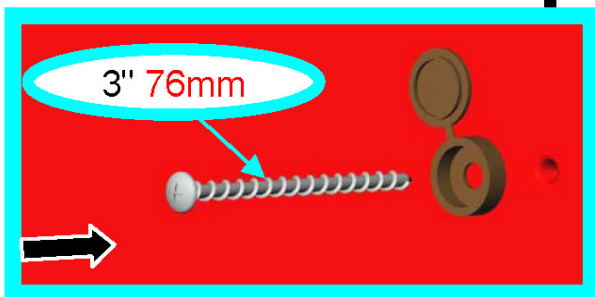
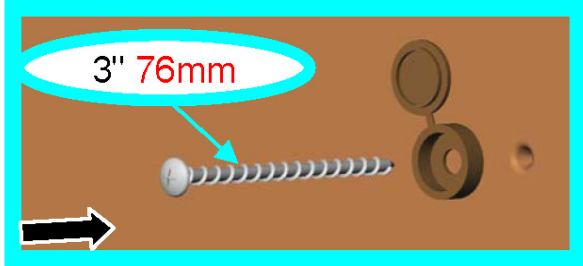

5
6

7
8

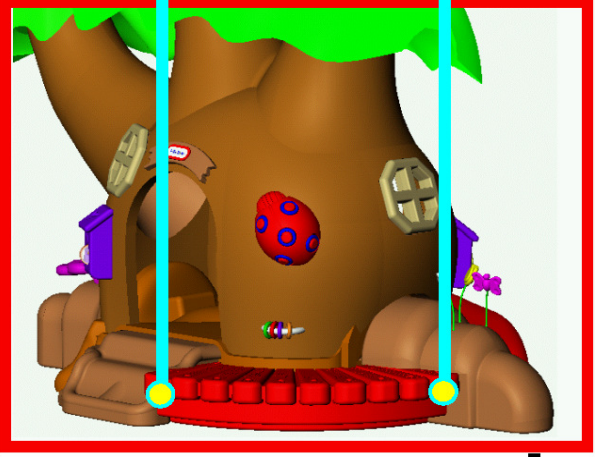
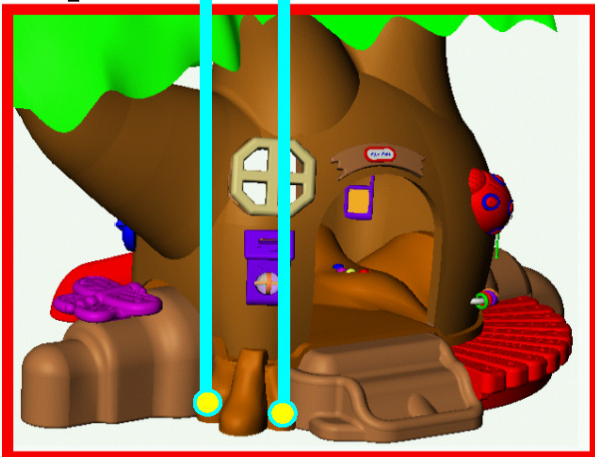

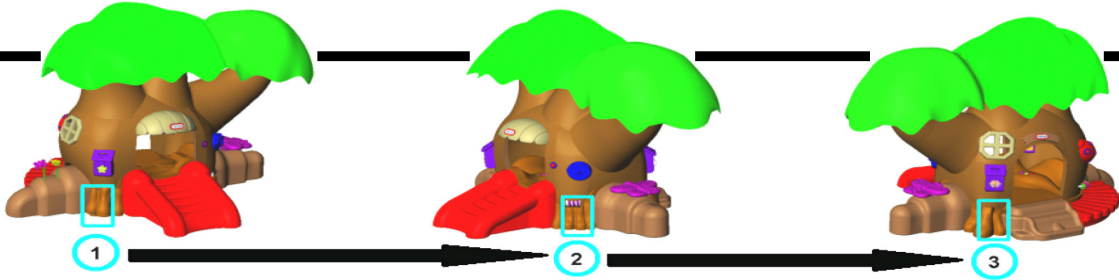

IN GROUND

SURFACE MOUNT

