

HAGS

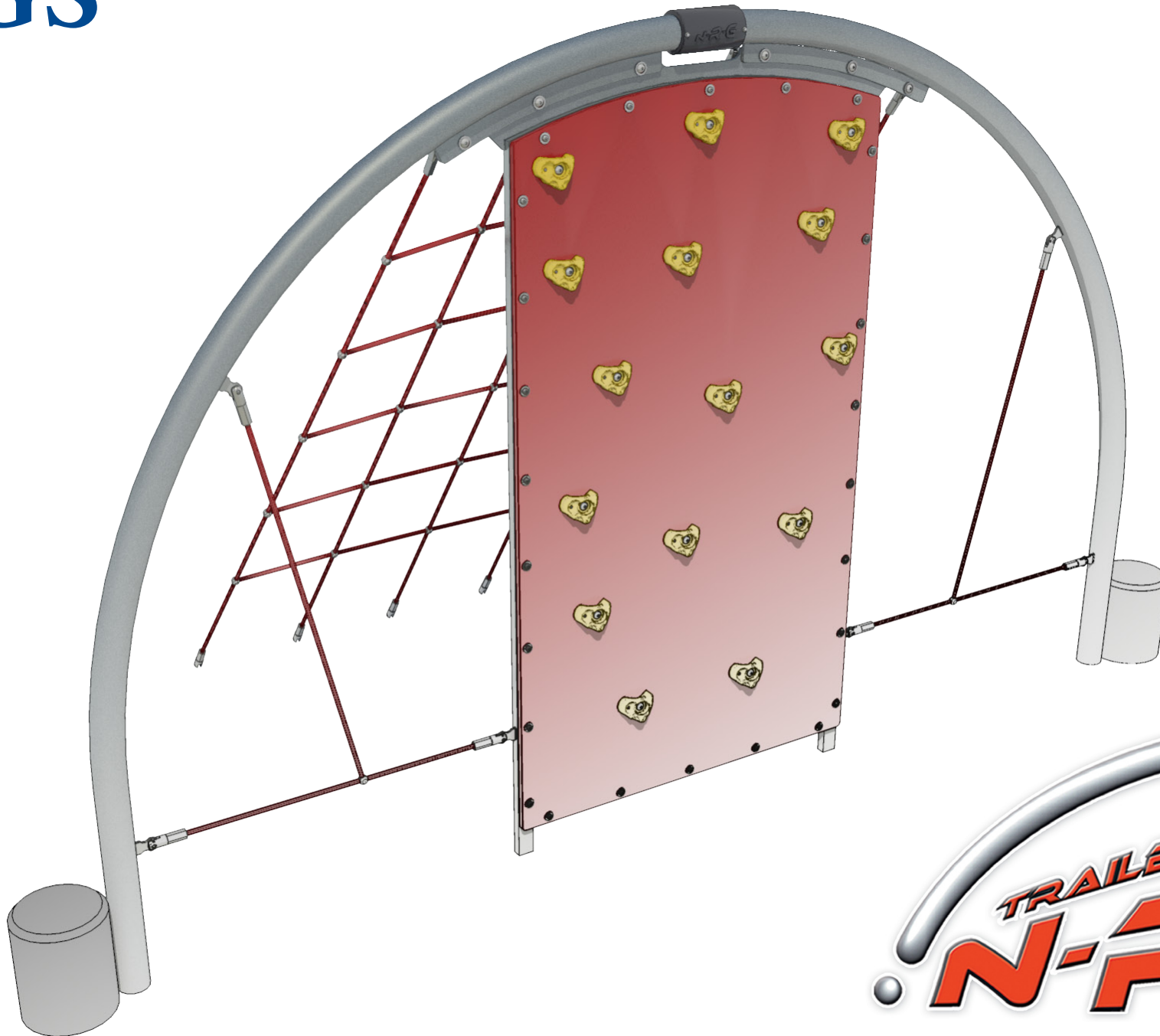
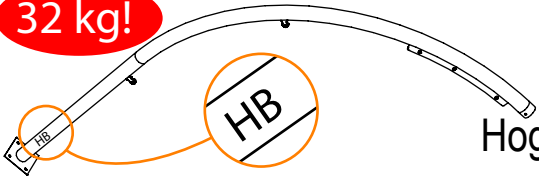

NG205 - HOGS BACK

1 **32 kg!**  **78803113**
2 No
 Hogs Back Half Arch

3  **10131030**
19 No
 M10x30mm Resistor

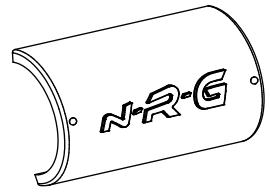
5  **78804042**
2 No
 NRG Joint Cover

7  **78804031**
1 No
 Tube Clear Silicone Sealant

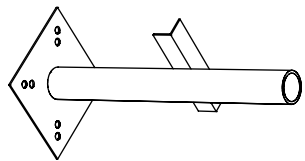
9  **803703**
2 No
 300mm Bollard Fix Post

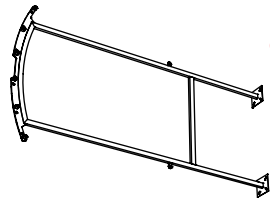
11  **41 kg!** **78803040**
1 No
 HDPE Support Frame

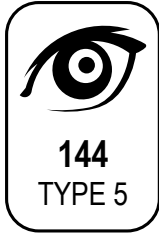
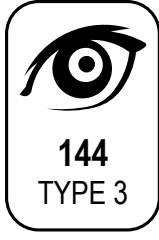

2  **78804035**
1 No
 NRG Arch Spigot

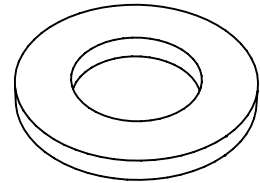
4  **10381000**
45 No
 M10 Form 'A' Washer

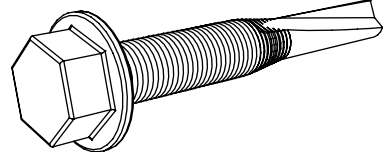
6  **10050540**
4 No
 M5x40mm Tech Screw

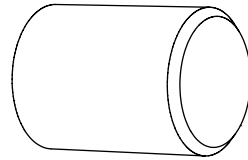
8  **RYBL300**
2 No
 300mm Black Bollard

10  **RYADHBK**
1 No
 Bollard Adhesive
<http://www.alansonsuk.com/downloads.asp>

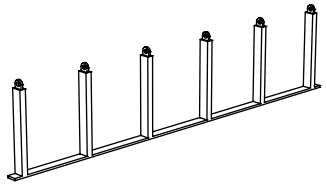
12  **78803008**
1 No
 Rope Net Anchor Bar

13  **78805046**
1 No
 Hogs Back Scramble Net

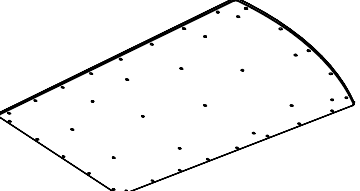
15  **78804062**
1 No
 Climbing Wall Panel

48kg!

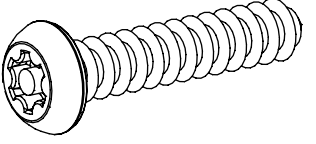
17  **10051025**
15 No
 1" Self Tapping Screw

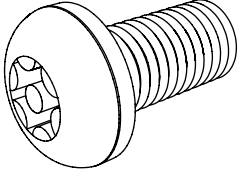
19  **10131020**
6 No
 M10 x 20 Resistorx

21  **10291400**
6 No
 Washer

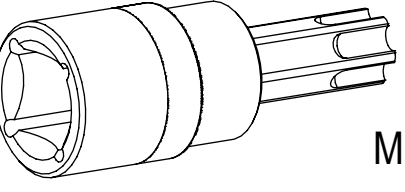
23  **950100**
1 No
 M10 Resistorx Fixing Tool

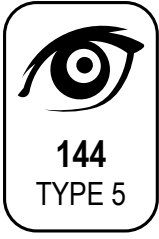
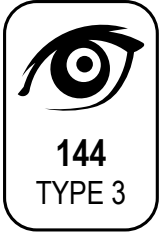
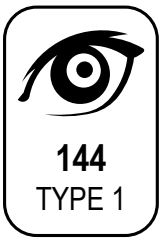

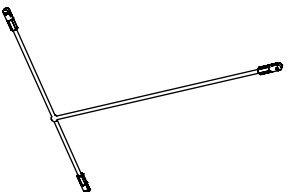
14  **78805047**
2 No
 Hogs Back Side 'T' Rope

16  **78904012**
15 No
 Yellow Climbing Grip

18  **10301004**
21 No
 M10 x 20 1372 Barrel Nut

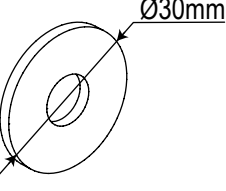
20  **10309999**
6 No
 Large M10 Washer

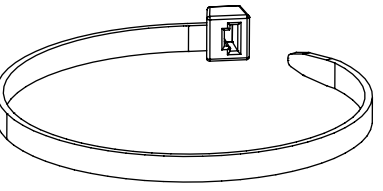
22  **78804044**
2 No
 1220mm Long Cable Tie

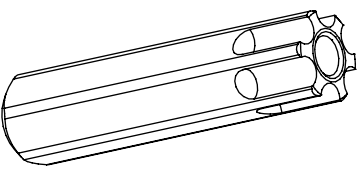
24  **10121001**
1 No
 M12 Resistorx Fixing Tool

25

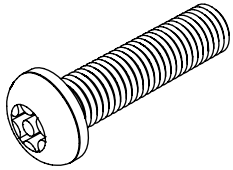

10131040
26 No
M10 x 40 Resistorx



26

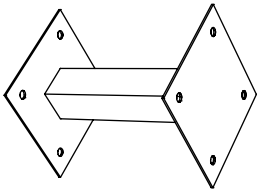

305802
6 No
Extension Unit

27

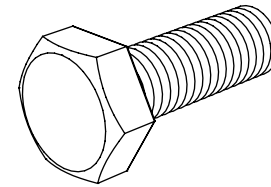

10251030
24 No
M10 x 30 Bolt

28

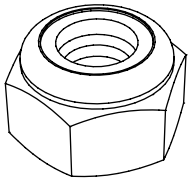

10321000
24 No
M10 Nyloc Nut

29

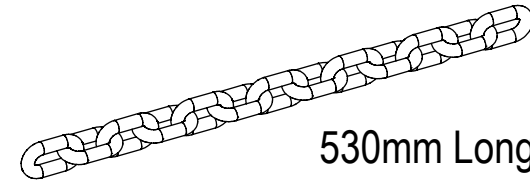

78804008
6 No
530mm Long Extension Chain

30

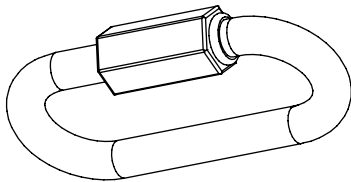

109309
12 No
Quick Repair Link



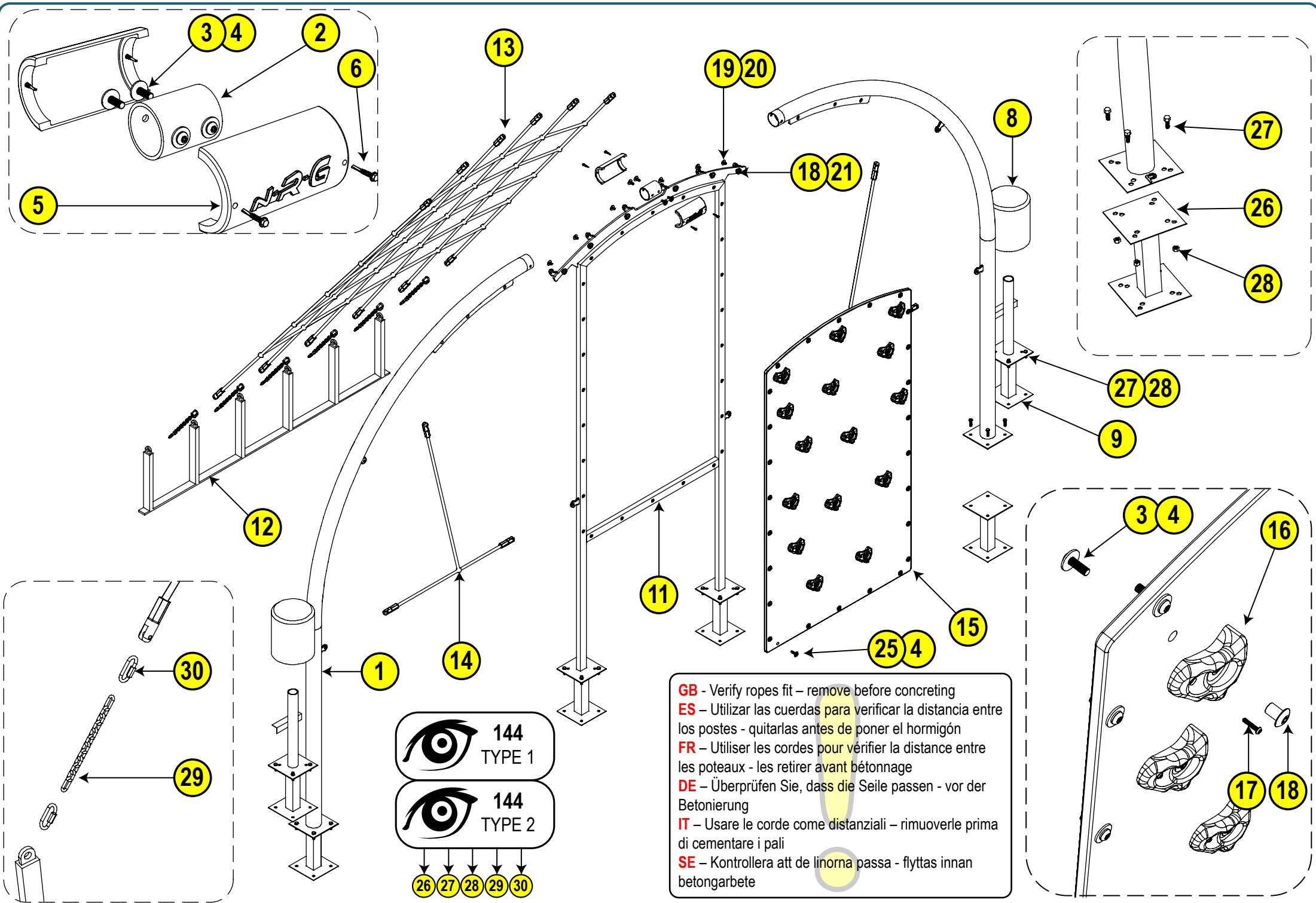

GB - Verify ropes fit – remove before concreting
ES – Utilizar las cuerdas para verificar la distancia entre los postes - quitarlas antes de poner el hormigón
FR – Utiliser les cordes pour vérifier la distance entre les poteaux - les retirer avant bétonnage
DE – Überprüfen Sie, dass die Seile passen - vor der Betonierung
IT – Usare le corde come distanziali – rimuoverle prima di cementare i pali
SE – Kontrollera att de linorna passa - flyttas innan betongarbete

LxWxH (m)
3.67 x 1.77 x 2.40

kg
271

m³
0.95

m²
15 x 15

EN1176
H=2.4m

X 3 = T
T = 6 hr

S2 (50mm)
≥C20-25

7 x 24h

101

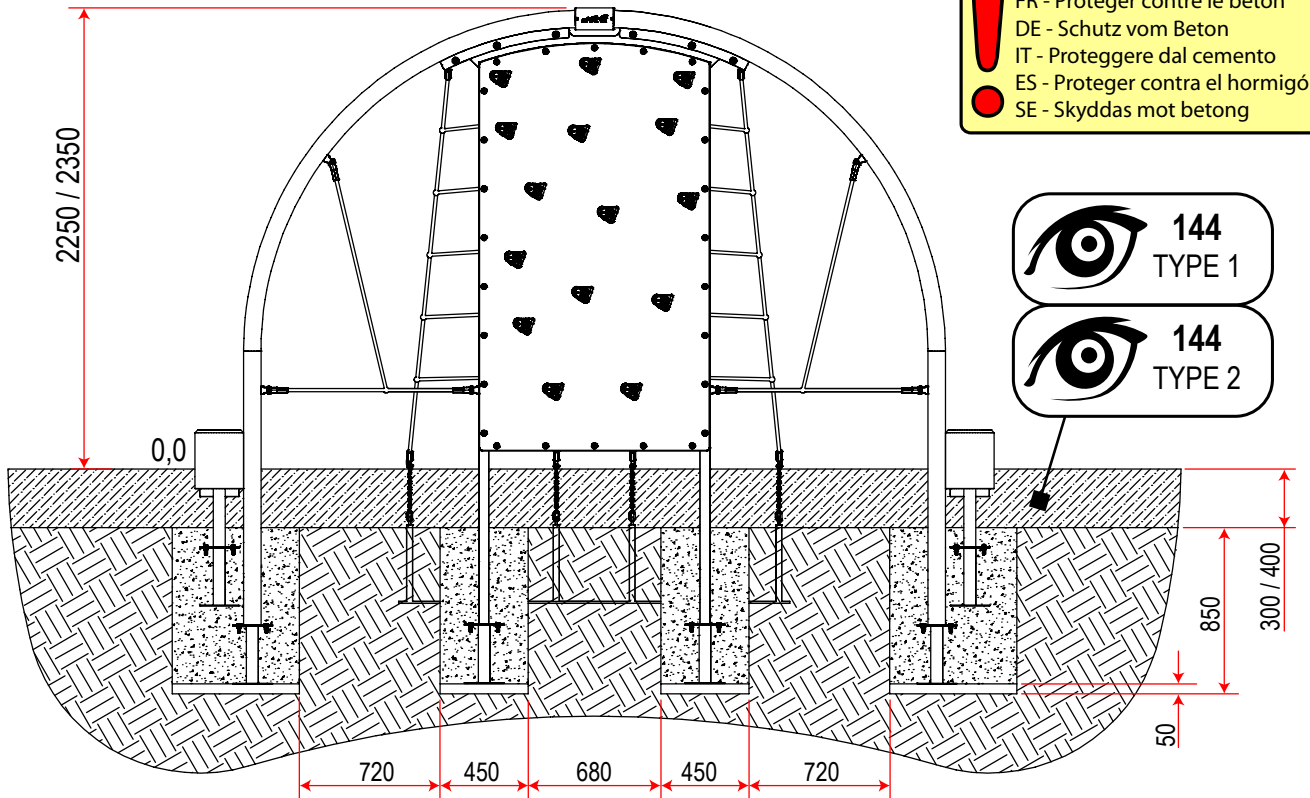
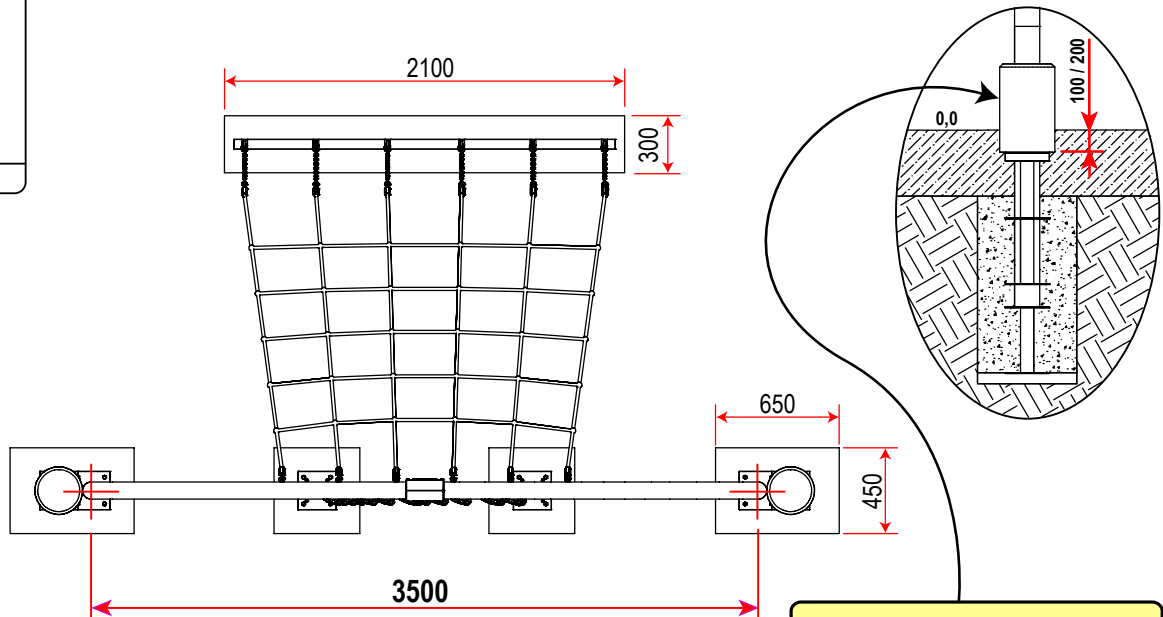
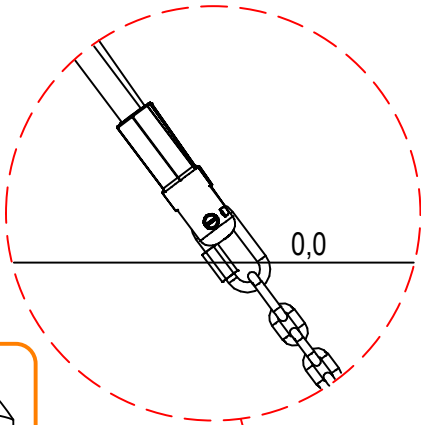
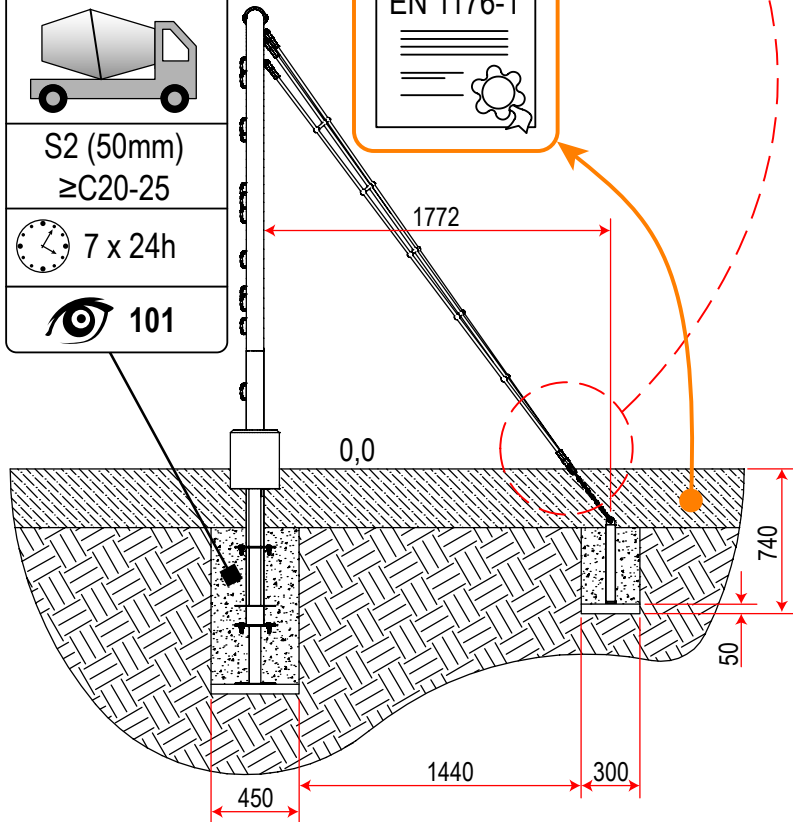

EN 1176-1





- GB - Protect from concrete
- FR - Protéger contre le beton
- DE - Schutz vom Beton
- IT - Proteggere dal cemento
- ES - Proteger contra el hormigón
- SE - Skyddas mot betong

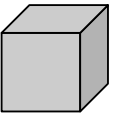
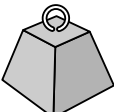

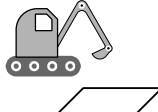
144
TYPE 1

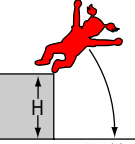
144
TYPE 2

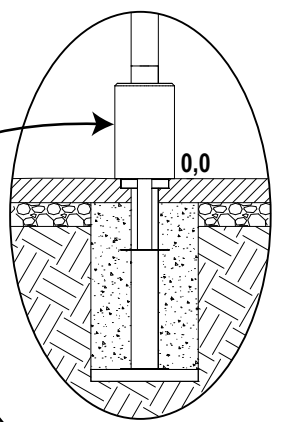
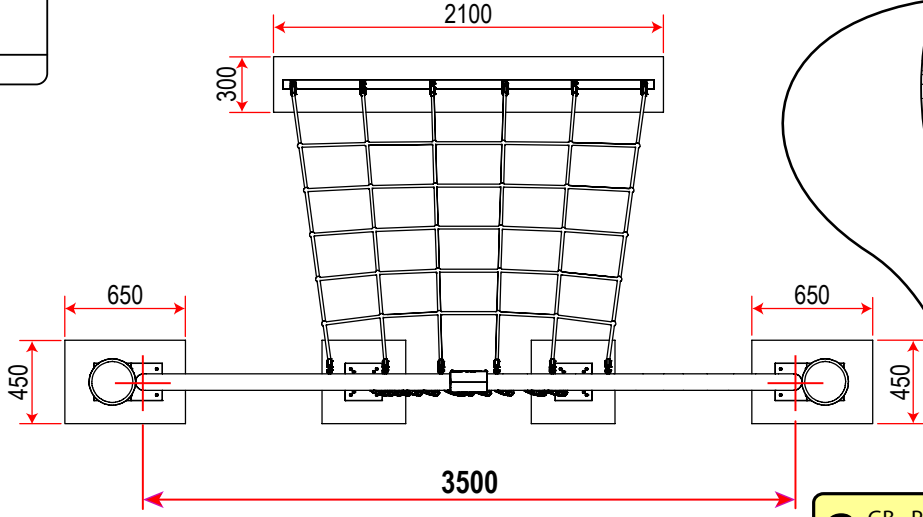
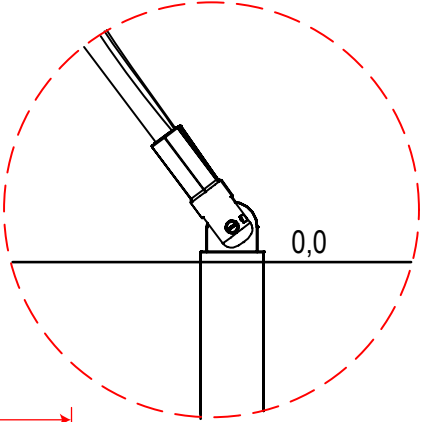

			
LxWxH (m)	kg	m ³	m ²
3.67 x 1.77 x 2.40	228	0.95	15 x 15

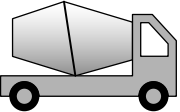
	
EN1176	X 3 = T
H=2.4m	T = 6 hr



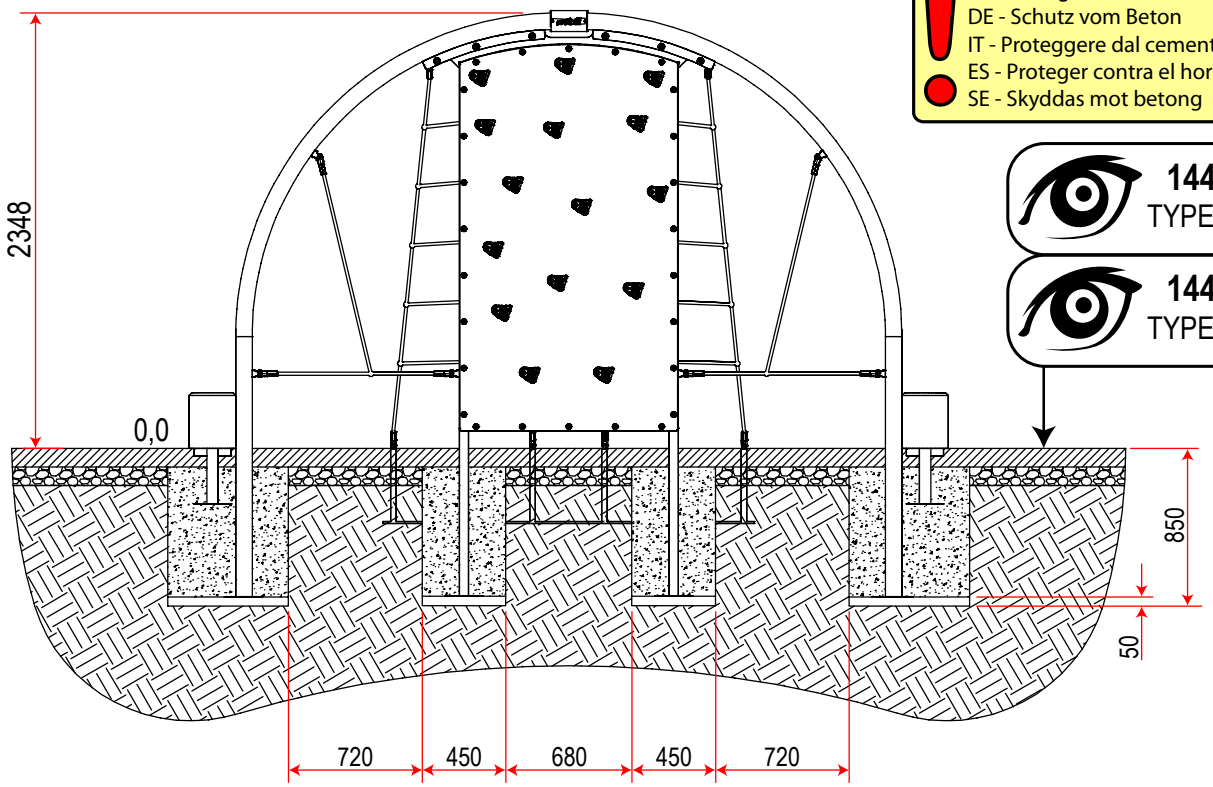
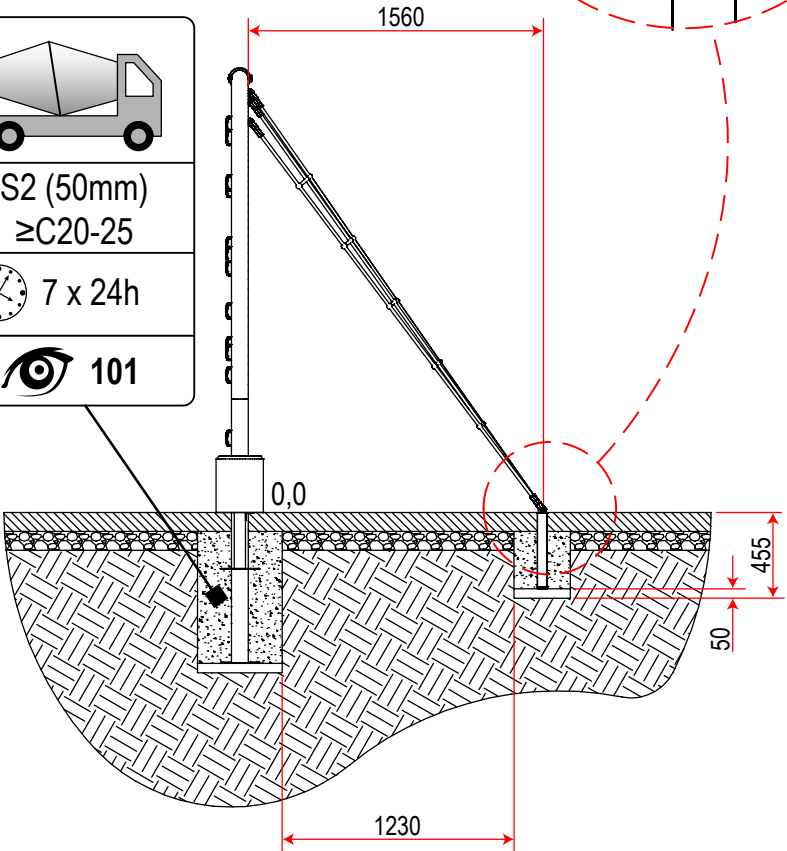

S2 (50mm)
≥C20-25
 7 x 24h
 101

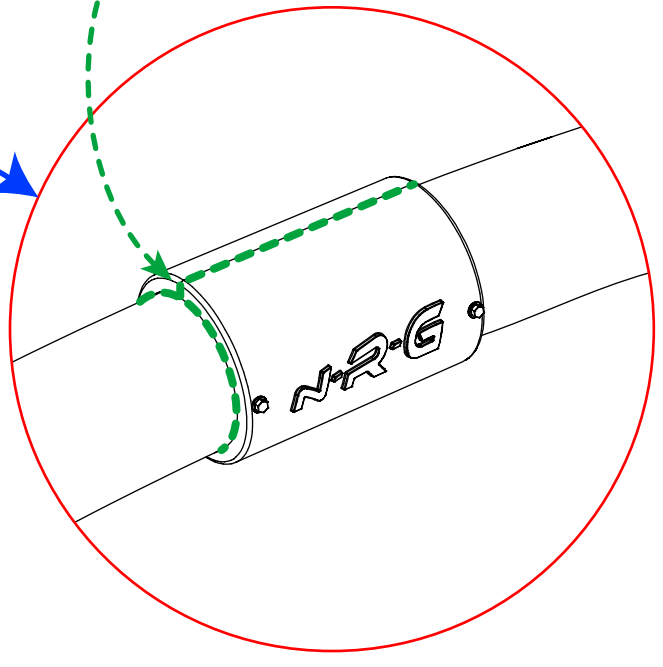
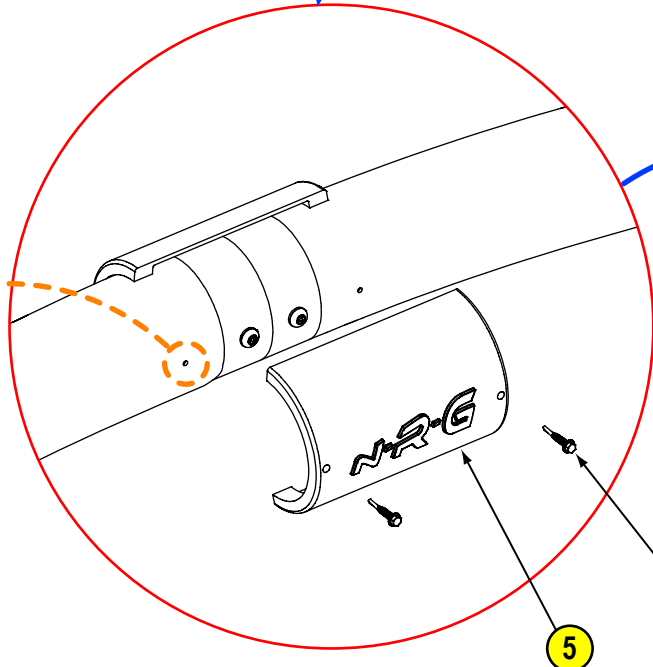
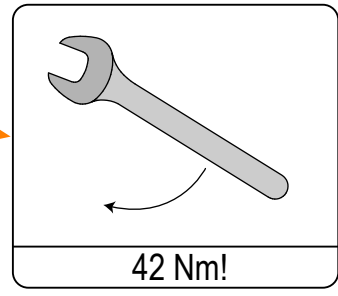
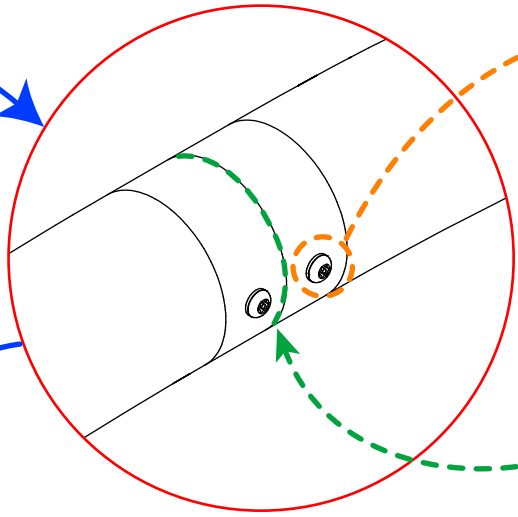
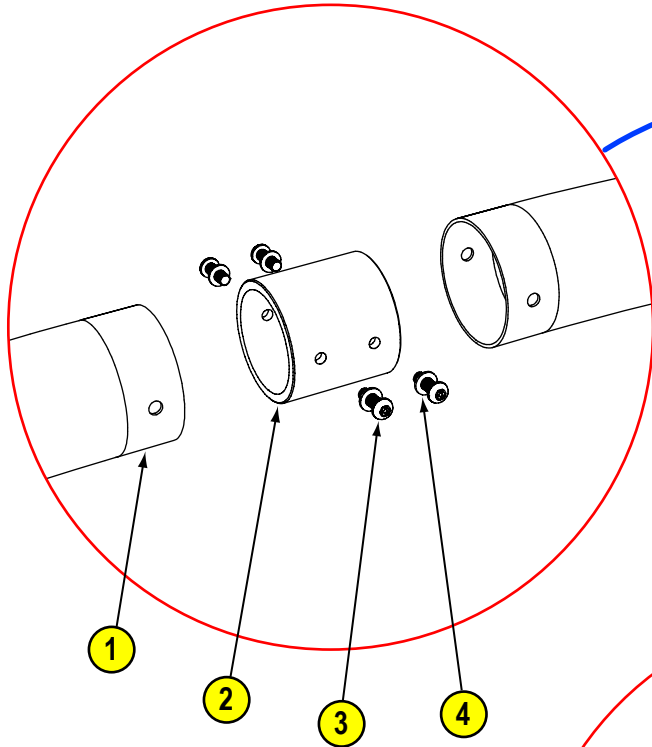

	GB - Protect from concrete
	FR - Protéger contre le béton
	DE - Schutz vom Beton
	IT - Proteggere dal cemento
	ES - Proteger contra el hormigón
	SE - Skyddas mot betong

	144
	TYPE 3
	144
	TYPE 5



- ! GB - Protect from concrete
- FR - Protéger contre le béton
- DE - Schutz vom Beton
- IT - Proteggere dal cemento
- ES - Proteger contra el hormigón
- SE - Skyddas mot betong

